



Wersja z wyrzutem poziomym (CTHB, CTHT)



Wersja z wyrzutem pionowym, modele od 140 do 400

Wersja z wyrzutem pionowym, modele od 450 do 710

ZASTOSOWANIE

Wentylacja wywiewna:

- magazynów, hal sklepowych i przemysłowych,
- budynków gospodarczych w rolnictwie, itp.,
- odciągi z nad rusztów, z akapów w przemyśle mięsnym oraz gastronomii,
- odciągi pary wodnej i mgły z zanieczyszczeniami tłuszczowymi (wersja w wyrzutem pionowym),
- wyciągu dymu z kominków (modele 180-225),
- wentylacja pożarowa (F400/120)*.

KONSTRUKCJA

- podstawa z ocynkowanej blachy stalowej,
- wirnik promieniowy z łopatkami zakrzywionymi do tyłu wykonany z ocynkowanej blachy stalowej,
- osłona wykonana z pręta aluminiowego,
- wszystkie modele są wyposażone w osłony przeciw ptakom.

SILNIK

- jednofazowy, jednobiegowy silnik 220-240V, 50Hz (CTHB),
- trójfazowy jednobiegowy silnik 220-240/400-415V-50Hz (CTHT, CTVT),
- trójfazowy 2-biegowy silnik 380-415V 50Hz, 4-8 biegunów,
- klasa izolacji F,
- stopień IP 55,
- termiczne zabezpieczenie przed przeciążeniem**,
- regulacja napięciowa (silniki jednofazowe)***,
- regulacja częstotliwościowa i napięciowa (silniki trójfazowe)***.

* Poza modelami 180 i 200.

** Po podłączeniu zabezpieczenia termicznego instalacja elektryczna musi być wyposażona w system bezpieczeństwa, który w przypadku pożaru pozwala na uruchomienie maksymalnej prędkości wentylatorów bez względu na aktualny stan zabezpieczenia termicznego.

*** W przypadku korzystania ze sterownika prędkości instalacja elektryczna musi być wyposażona w system bezpieczeństwa, który pozwala, w przypadku pożaru, na uruchomienie maksymalnej prędkości wentylatorów.



Łatwy montaż

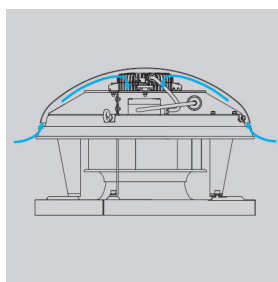

System chłodzenia

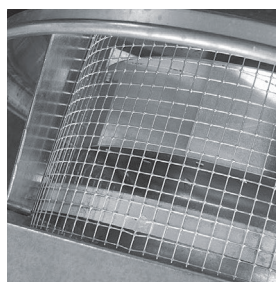

Zabezpieczenie przed ptakami

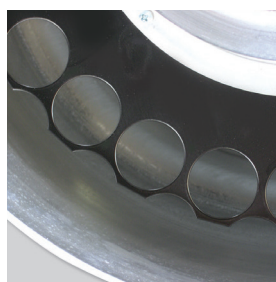
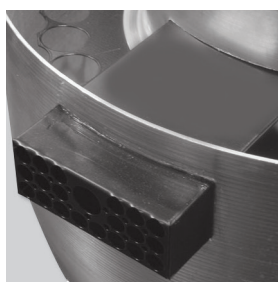
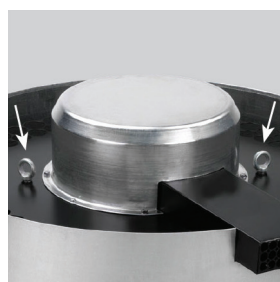

DANE TECHNICZNE - WYLOT POZIOMY

Typ	prędkość obrotowa	pobór mocy max***	natężenie 230V** 400V		wydajność max	poziom ciśn. akust.* wlot wylot		masa	nr artykułu
	[obr/min]	[W]	[A]		[m³/h]	[dB(A)]		[kg]	
SILNIKI CZTEROBIEGUNOWE JEDNOFAZOWE									
CTHB/4-180N	1290	65	0,3 (0,3)	-	900	44	48	10,8	43524020-10
CTHB/4-200N	1410	87	0,4 (0,5)	-	1260	48	53	18	43524030-10
CTHB/4-225N	1410	163	0,7 (1)	-	2000	51	56	20	43524040-10
CTHB/4-250N	1400	295	1,3 (1,6)	-	2750	52	58	32	43524050-10
CTHB/4-315N	1410	583	2,6 (3,2)	-	4440	60	65	35	43524060-10
CTHB/4-400N	1410	1168	5,1 (6,5)	-	7120	66	73	51,5	43524070-10
SILNIKI SZĘŚCIOBIEGUNOWE JEDNOFAZOWE									
CTHB/6-200N	920	34	0,1 (0,2)	-	820	38	42	17,5	43524110-10
CTHB/6-225N	900	61	0,3 (0,3)	-	1330	40	43	22,5	43524120-10
CTHB/6-250N	900	91	0,4 (0,4)	-	1770	42	47	30,5	43524130-10
CTHB/6-315N	900	179	0,8 (0,8)	-	2900	49	53	33	43524140-10
CTHB/6-400N	920	353	1,6 (1,8)	-	4640	55	61	46	43524150-10
SILNIKI CZTEROBIEGUNOWE TRÓJFAZOWE									
CTHT/4-180N	1280	60	0,2	0,1	900	44	48	10,8	43524220-10
CTHT/4-200N	1400	84	0,3	0,2	1250	48	52	17,5	43524230-10
CTHT/4-225N	1400	163	0,5	0,3	2010	51	55	18,5	43524240-10
CTHT/4-250N	1370	279	1,0	0,6	2710	52	58	31,5	43524250-10
CTHT/4-315N	1400	548	1,9	1,1	4490	60	65	33	43524260-10
CTHT/4-400N	1430	1126	4,2	2,4	7120	65	73	49,5	43524270-10
CTHT/4-450	1440	2300	-	4,6	10200	71	76	67	43524280
SILNIKI SZĘŚCIOBIEGUNOWE TRÓJFAZOWE									
CTHT/6-200N	1310	73	0,5	0,3	870	37	41	17,5	43524310-10
CTHT/6-225N	910	62	0,2	0,1	1310	40	43	19,5	43524320-10
CTHT/6-250N	880	89	0,3	0,2	1760	41	46	30,5	43524330-10
CTHT/6-315N	910	180	0,7	0,4	2890	49	53	35	43524340-10
CTHT/6-400N	930	344	1,4	0,8	4770	55	61	44	43524350-10
CTHT/6-450	940	850	-	3,50	6900	59	66	67	43524360
CTHT/6-500	965	1400	-	4,30	10500	63	69	104	43524370
CTHT/6-560	950	2400	-	5,30	16000	66	73	118	43524380
CTHT/6-630	950	3900	-	8,30	21000	70	76	156	43524390
CTHT/6-630H	970	5500	-	12,60	31090	75	81	210	
CTHT/6-710	980	6800	-	13,80	28900	77	83	217	43524400
CTHT/6-710H	970	7500	-	15,80	38120	77	83	228	43524401
SILNIKI OSMIOBIEGUNOWE TRÓJFAZOWE									
CTHT/8-450	700	700	-	2,10	5000	55	61	67	43524510
CTHT/8-500	725	770	-	2,40	7500	55	62	104	43524520
CTHT/8-560	730	1100	-	3,60	11500	58	65	118	43524530
CTHT/8-630	735	1650	-	4,90	15000	62	69	156	43524540
CTHT/8-710	730	2900	-	7,20	21700	70	76	226	43524550
SILNIKI DWUBIEGUNOWE TRÓJFAZOWE									
CTHT/4/8-225N	1380/710	163/79	-	0,3/0,2	1950/1000	51/36	55/40	18,5	43524246
CTHT/4/8-250N	1370/720	280/145	-	0,6/0,4	2750/1390	52/38	58/44	31,5	43524251
CTHT/4/8-315N	1400/700	548/260	-	1,1/0,9	4490/2240	60/45	65/50	33	43524266
CTHT/4/8-400N	1350/710	497/181	-	0,9/0,6	4330/2160	59/46	64/51	49,5	43524276
CTHT/4/8-450	1400/700	2400/600	-	6,1/2,5	10200/5100	71/55	76/61	69	43524285
CTHT/6/12-450	960/490	500/190	-	2/1	6900/3400	59/44	66/51	72	43524365
CTHT/6/12-500	980/490	1520/430	-	4,5/2,2	10500/5300	63/48	69/54	109	43524375
CTHT/6/12-560	950/480	2400/640	-	5,5/2,2	16000/7000	66/51	73/58	124	43524385
CTHT/6/12-630	960/480	4100/730	-	8,1/2,6	21000/10500	70/55	76/61	161	43524395
CTHT/6/12-710	950/450	6700/850	-	14,1/5,4	28900/15000	77/62	83/68	226	43524405

* Poziom ciśnienia akustycznego mierzony w odległości 3m przy propagacji półkulistej, w punkcie pracy 2 krzywej wydajności.

** (w nawiasach): maksymalny prąd przy prędkości regulowanej napięciowo.

*** Przy 50Hz bez VSD

DANE TECHNICZNE - WYLOT PIONOWY

Typ	prędkość obrotowa	pobór mocy max***	natężenie 230V** 400V		wydajność max	poziom ciśn. akust.* wlot wylot		masa	nr artykułu
	[obr/min]	[W]	[A]		[m³/h]	[dB(A)]		[kg]	
SILNIKI CZTEROBIEGUNOWE JEDNOFAZOWE									
CTVB/4-180N	1310	73	0,3 (0,3)	-	870	45	49	11,7	43524620-10
CTVB/4-200N	1410	89	0,4 (0,5)	-	1260	48	51	19,5	43524630-10
CTVB/4-225N	1400	166	0,7 (0,9)	-	1910	53	57	19	43524640-10
CTVB/4-250N	1390	299	1,3 (1,6)	-	2690	55	58	35,5	43524650-10
CTVB/4-315N	1410	587	2,7 (3,4)	-	4340	59	62	35,5	43524660-10
CTVB/4-400N	1420	1170	5,1 (6)	-	6700	65	69	53	43524670-10
SILNIKI SZĘŚCIOBIEGUNOWE JEDNOFAZOWE									
CTVB/6-200N	910	34	0,2 (0,2)	-	810	40	44	19,5	43524710-10
CTVB/6-225N	900	61	0,3 (0,3)	-	1220	39	42	20	43524720-10
CTVB/6-250N	900	90	0,4 (0,4)	-	1770	43	46	34	43524730-10
CTVB/6-315N	900	180	0,8 (0,9)	-	2810	48	51	38	43524740-10
CTVB/6-400N	920	345	1,6 (1,8)	-	4400	55	58	47,5	43524750-10
SILNIKI CZTEROBIEGUNOWE TRÓJFAZOWE									
CTVT/4-180N	1260	62	0,2	0,1	840	45	48	11,7	43524820-10
CTVT/4-200N	1390	86	0,3	0,2	1230	48	50	19,5	43524830-10
CTVT/4-225N	1390	164	0,5	0,3	1830	53	57	22,5	43524840-10
CTVT/4-250N	1370	277	1,0	0,6	2660	54	57	35,5	43524850-10
CTVT/4-315N	1400	538	2,1	1,2	4320	58	62	35,5	43524860-10
CTVT/4-400N	1430	1139	4,0	2,3	6760	64	69	51	43524870-10
CTVT/4-450	1440	2100	-	4,3	8850	70	74	75	43524880
CTVT/4-632 HP 5,5kW	1465	6,10	-	10,9	18000	-	84	177	43529030
CTVT/4-631 HP 7,5kW	1480	6,67	-	12,4	20700	-	85	180	43529010
CTVT/4-712 HP 11kW	1470	12,25	-	21,3	26000	-	88	267	43529070
CTVT/4-711 HP 15kW	1480	16,39	-	29,5	32500	-	90	303	43529050
CTVT/4-802 HP 18,5kW	1480	19,85	-	34,5	35400	-	91	361	43529110
CTVT/4-801 HP 22kW	1485	26,00	-	43,6	44500	-	93	376	43529090
CTVT/4-632 5,5kW INS	1465	6,10	-	10,9	18000	-	78	221	43529040
CTVT/4-631 7,5kW INS	1480	6,67	-	12,4	20700	-	79	224	43529020
CTVT/4-712 11kW INS	1470	12,25	-	21,3	26000	-	81	357	43529080
CTVT/4-711 15kW INS	1480	16,39	-	29,5	32500	-	83	393	43529060
CTVT/4-802 18,5kW INS	1480	19,85	-	34,5	35400	-	84	492	43529120
CTVT/4-801 22kW INS	1485	26,00	-	43,6	44500	-	87	507	43529100
SILNIKI SZĘŚCIOBIEGUNOWE TRÓJFAZOWE									
CTVT/6-200N	890	31	0,2	0,1	780	39	43	19	43524910-10
CTVT/6-225N	900	61	0,2	0,1	1210	40	43	22	43524920-10
CTVT/6-250N	880	86	0,3	0,2	1710	43	46	34	43524930-10
CTVT/6-315N	900	180	0,7	0,4	2800	48	51	39	43524940-10
CTVT/6-400N	930	345	1,4	0,8	4400	56	58	45,5	43524950-10
CTVT/6-450	950	800	-	3,5	5900	59	63	75	43524960
CTVT/6-500	975	1500	-	3,7	9500	62	66	115	43524970
CTVT/6-560	950	2400	-	5,2	13000	66	70	129	43524980
CTVT/6-630	950	3900	-	8,3	19500	70	74	168	43524990
CTVT/6-630H	970	5500	-	12,70	24540	74	80	215	43524991
CTVT/6-710	980	7250	-	13,6	25200	77	82	229	43524993
CTVT/6-710H	980	7500	-	16,20	32820	77	82	240	43524994
SILNIKI OSMIOBIEGUNOWE TRÓJFAZOWE									
CTVT/8-450	690	700	-	1,5	4400	55	59	75	43525010
CTVT/8-500	700	770	-	2,4	7100	54	58	115	43525020
CTVT/8-560	730	1100	-	3,3	10000	58	62	129	43525030
CTVT/8-630	735	1650	-	4,90	14500	61	66	168	43525040
CTVT/8-710	730	3160	-	7,10	19100	71	76	238	43525050

* Poziom ciśnienia akustycznego mierzony w odległości 3m przy propagacji półkulistej, w punkcie pracy 2 krzywej wydajności.

** (w nawiasach): maksymalny prąd przy prędkości regulowanej napięciowo.

*** Przy 50Hz bez VSD

DANE TECHNICZNE - WYLOT PIONOWY

Typ	prędkość obrotowa	pobór mocy max***	natężenie 230V** 400V		wydajność max	poziom ciśn. akust.* wlot wylot		masa	nr artykułu
	[obr/min]	[W]	[A]		[m³/h]	[dB(A)]		[kg]	
SILNIKI CZTEROBIEGUNOWE JEDNOFAZOWE									
CTVT/4/8-225N	1380(710)	163(79)	-	0,3(0,2)	1770(900)	53/38	56/42	18,5	43524846
CTVT/4/8-250N	1370(720)	280(145)	-	0,6(0,4)	2670(1360)	54/40	57/43	31,5	43524851
CTVT/4/8-315N	1400(700)	548(260)	-	1,1(0,9)	4490(2240)	60/45	65/50	33	43524866
CTVT/4/8-400N	1430(710)	1080(-)	-	1,85(-)	6775(3320)	58/44	61/48	49,5	43524876
CTVT/4/8-450	1400(700)	2400(600)	-	6,1(2,5)	9850(4500)	70/55	74/59	77	43524885
CTVT/6/12-450	960(490)	500(190)	-	2/1	5900(2800)	59/44	63/48	80	43524965
CTVT/6/12-500	980(490)	1520(430)	-	4,5(2,2)	9500(4800)	62/47	66/51	134	43524975
CTVT/6/12-560	960(480)	2400(640)	-	5,6(2,2)	13000(6400)	66/51	70/55	134	43524985
CTVT/6/12-630	960(480)	4100(730)	-	8,1(2,6)	19500(9500)	70/54	74/59	173	43524995
CTVT/6/12-710	950(450)	7300(435)	-	14(5,4)	25200(12700)	77/63	82/67	238	43524996

* Poziom ciśnienia akustycznego mierzony w odległości 3m przy propagacji półkulistej, w punkcie pracy 2 krzywej wydajności.

** (w nawiasach): maksymalny prąd przy prędkości regulowanej napięciowa.

*** Przy 50Hz bez VSD

CHARAKTERYSTYKI PRACY

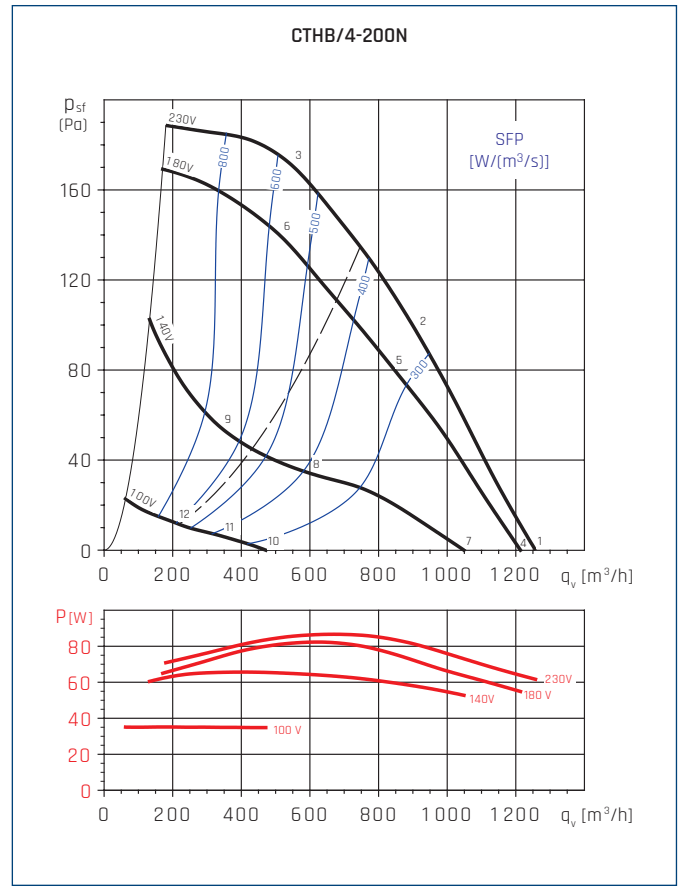
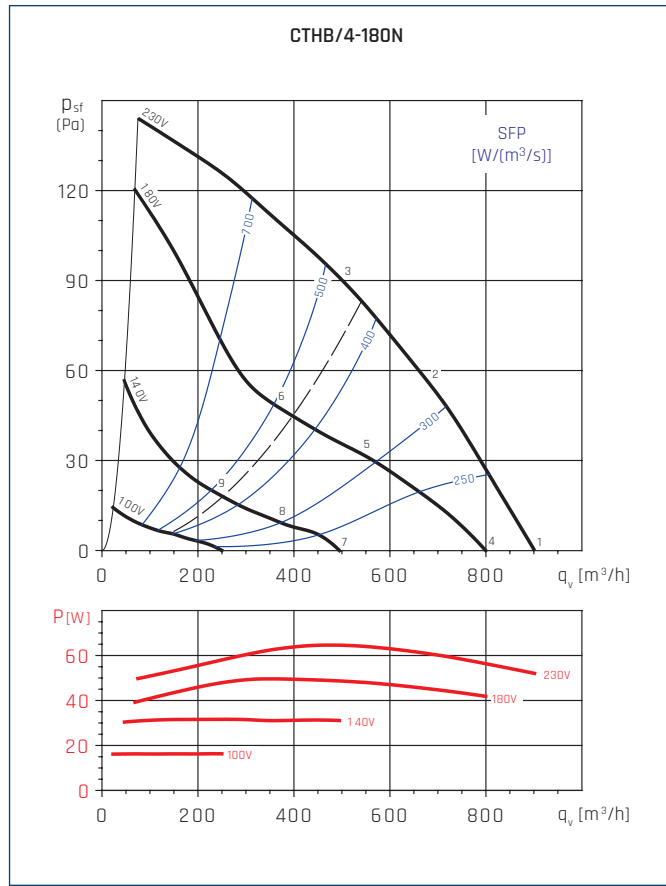

Poziom mocy akustycznej [dB(A)]

Punkt pracy		63	125	250	500	1000	2000	4000	8000	L _{WA}
1	Wlot	34	49	53	59	56	55	62	46	65
	Wylot	35	49	56	61	63	62	64	48	69
2	Wlot	34	46	52	57	54	53	55	43	62
	Wylot	33	46	55	59	60	59	57	45	66
3	Wlot	33	43	51	56	53	52	52	43	60
	Wylot	30	44	52	58	59	58	53	44	64
4	Wlot	31	46	51	56	53	53	60	44	63
	Wylot	32	46	54	58	60	59	62	45	66
5	Wlot	28	40	46	52	49	48	50	38	56
	Wylot	27	41	49	54	55	54	51	40	60
6	Wlot	27	37	44	50	46	45	45	36	54
	Wylot	23	37	45	51	52	51	46	38	57
7	Wlot	21	36	41	46	44	43	50	34	53
	Wylot	22	36	44	49	50	49	52	35	56
8	Wlot	18	30	36	41	38	38	39	28	46
	Wylot	17	30	39	43	44	44	41	29	50
9	Wlot	17	27	34	40	36	35	35	26	44
	Wylot	13	27	35	41	42	41	36	28	47

Poziom mocy akustycznej [dB(A)]

Punkt pracy		63	125	250	500	1000	2000	4000	8000	L _{WA}
1	Wlot	33	49	57	59	58	58	64	46	67
	Wylot	34	57	60	65	66	64	65	51	71
2	Wlot	34	52	58	61	56	57	56	45	65
	Wylot	36	55	60	65	64	63	59	50	70
3	Wlot	37	50	57	61	56	58	56	46	65
	Wylot	38	53	60	65	65	63	59	51	70
4	Wlot	32	48	56	59	57	57	64	45	67
	Wylot	34	56	59	64	65	63	64	50	71
5	Wlot	32	50	57	59	54	55	54	43	63
	Wylot	34	53	59	63	63	61	57	48	68
6	Wlot	34	48	55	59	54	55	54	44	63
	Wylot	36	51	58	62	62	61	57	48	68
7	Wlot	29	45	53	56	54	54	61	42	63
	Wylot	30	53	56	61	62	60	61	47	68
8	Wlot	23	40	47	49	45	46	45	33	54
	Wylot	24	43	49	53	53	51	48	38	59
9	Wlot	25	38	46	49	44	46	44	34	53
	Wylot	26	41	48	53	53	51	47	39	58
10	Wlot	12	28	36	39	37	37	44	25	47
	Wylot	14	36	39	44	45	43	44	30	51
11	Wlot	8	26	32	34	30	31	30	19	39
	Wylot	10	28	34	38	38	37	33	23	44
12	Wlot	10	24	31	34	30	31	29	19	39
	Wylot	11	26	33	38	38	37	33	24	43

CHARAKTERYSTYKI PRACY

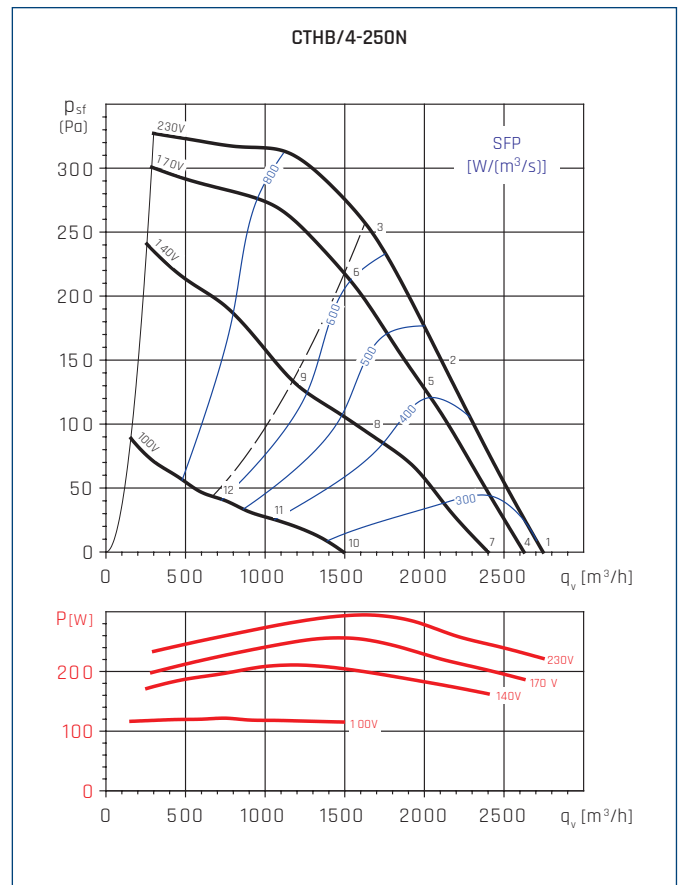
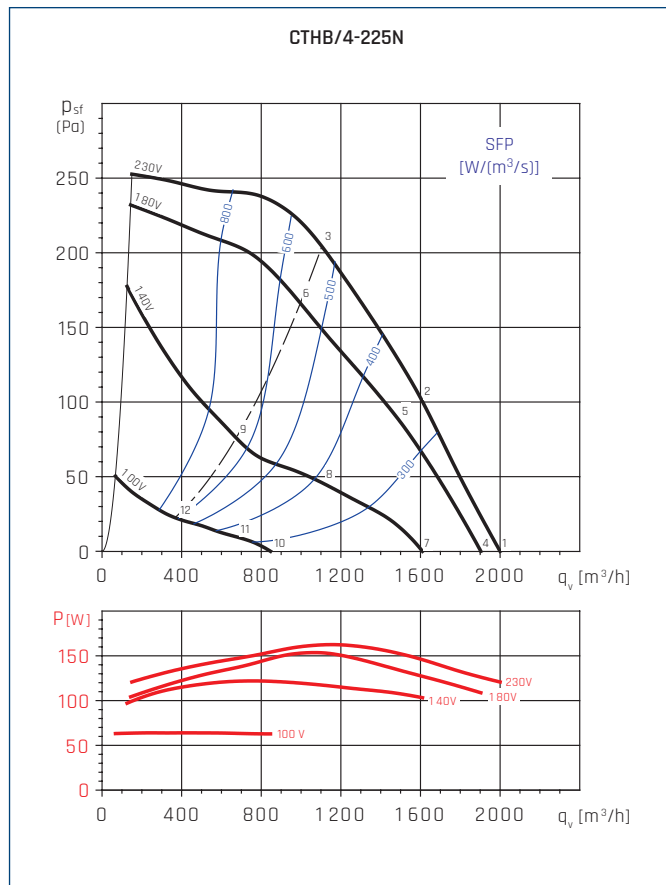

Poziom mocy akustycznej [dB(A)]

Punkt pracy		63	125	250	500	1000	2000	4000	8000	L _{WA}
1	Wlot	44	60	65	66	59	62	68	53	72
	Wylot	43	63	67	71	69	67	69	58	76
2	Wlot	44	57	63	64	58	60	59	47	69
	Wylot	44	59	64	68	67	66	62	52	73
3	Wlot	40	56	61	62	57	58	54	48	67
	Wylot	40	59	62	66	65	64	59	52	71
4	Wlot	43	59	64	65	58	61	67	52	71
	Wylot	42	62	66	70	68	66	68	57	75
5	Wlot	43	56	62	63	57	59	58	46	67
	Wylot	43	58	63	67	66	65	61	51	72
6	Wlot	38	54	59	60	55	56	52	46	64
	Wylot	38	57	60	64	63	62	57	50	69
7	Wlot	40	56	61	62	55	58	64	49	68
	Wylot	39	59	63	67	65	63	65	54	72
8	Wlot	36	49	55	56	50	52	51	39	61
	Wylot	36	51	56	60	59	58	54	44	65
9	Wlot	29	45	50	51	46	47	43	37	56
	Wylot	29	48	51	55	54	53	48	41	60
10	Wlot	26	42	47	48	41	44	50	35	54
	Wylot	25	45	49	53	51	49	51	40	58
11	Wlot	23	36	42	43	37	39	38	26	47
	Wylot	23	38	43	47	46	45	41	31	52
12	Wlot	16	32	37	38	33	34	30	24	43
	Wylot	16	35	38	42	41	40	35	28	48

Poziom mocy akustycznej [dB(A)]

Punkt pracy		63	125	250	500	1000	2000	4000	8000	L _{WA}
1	Wlot	45	61	66	68	62	64	67	57	73
	Wylot	47	65	71	74	72	70	68	61	79
2	Wlot	46	59	63	65	61	63	59	47	70
	Wylot	47	63	68	70	70	69	61	52	76
3	Wlot	43	57	62	64	62	61	55	50	69
	Wylot	44	61	66	70	70	67	61	54	75
4	Wlot	44	61	65	67	61	63	66	56	73
	Wylot	46	64	70	73	71	70	68	60	78
5	Wlot	45	58	62	63	59	62	57	46	69
	Wylot	46	61	67	69	68	68	60	51	74
6	Wlot	41	55	60	62	60	59	54	48	67
	Wylot	42	59	64	68	68	65	59	52	73
7	Wlot	42	59	63	65	60	61	65	54	71
	Wylot	44	63	68	71	69	68	66	58	76
8	Wlot	41	54	58	60	56	58	54	42	65
	Wylot	42	58	63	65	65	64	56	47	71
9	Wlot	36	50	55	57	55	54	49	43	62
	Wylot	37	54	59	63	63	60	54	47	68
10	Wlot	32	48	53	55	49	51	54	44	60
	Wylot	34	52	58	61	59	57	55	48	66
11	Wlot	29	42	46	47	43	46	41	30	53
	Wylot	30	45	51	53	52	52	44	35	58
12	Wlot	24	38	43	45	43	42	36	31	50
	Wylot	25	42	47	51	51	48	42	35	56

CHARAKTERYSTYKI PRACY

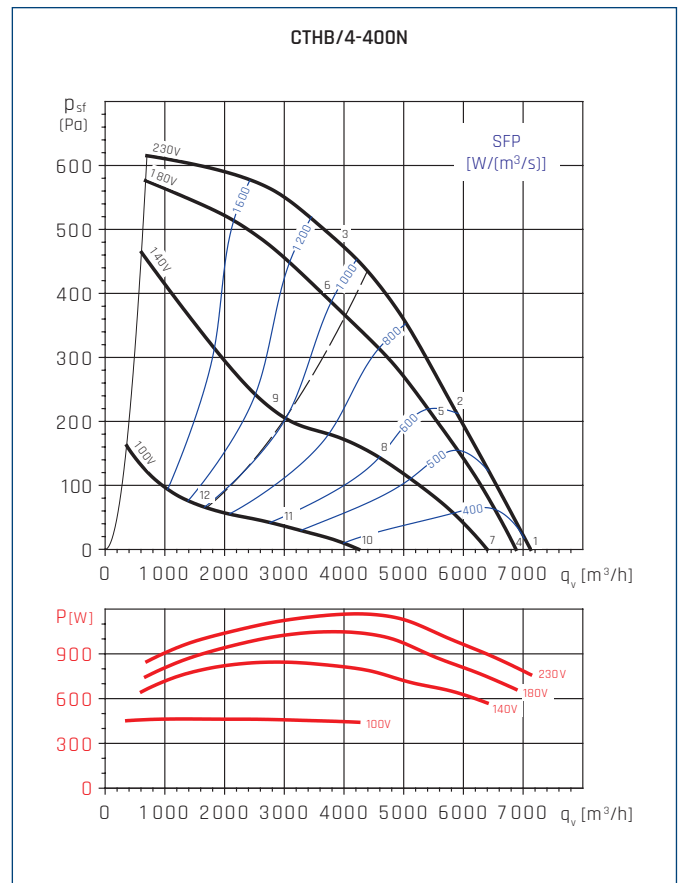
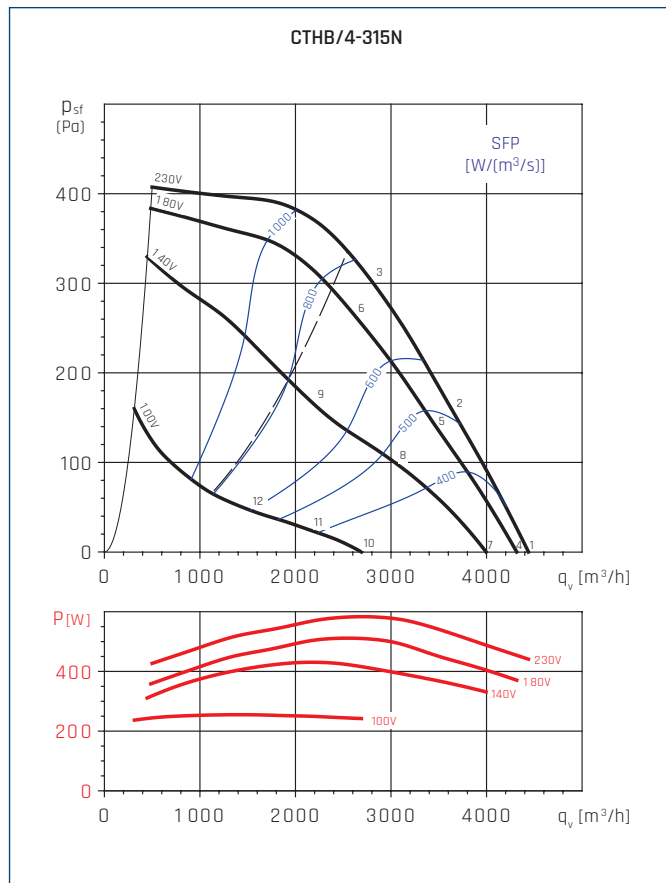

Poziom mocy akustycznej [dB(A)]

Punkt pracy		63	125	250	500	1000	2000	4000	8000	L _{WA}
1	Wlot	51	66	72	72	70	70	71	74	80
	Wylot	53	70	77	79	77	75	75	73	84
2	Wlot	51	64	72	71	69	68	68	69	78
	Wylot	52	70	75	78	76	73	71	70	83
3	Wlot	50	60	70	68	67	66	66	61	75
	Wylot	52	68	72	76	73	70	69	64	80
4	Wlot	50	66	71	71	70	69	70	73	79
	Wylot	52	69	76	79	77	74	74	72	84
5	Wlot	50	63	71	70	68	67	67	68	77
	Wylot	51	69	74	76	75	72	70	69	82
6	Wlot	49	59	68	66	65	64	65	60	73
	Wylot	50	66	71	75	71	69	68	63	79
7	Wlot	48	63	69	69	68	67	68	71	77
	Wylot	50	67	74	76	75	72	72	70	82
8	Wlot	46	59	67	66	64	63	63	64	73
	Wylot	47	65	70	73	71	68	66	65	78
9	Wlot	44	53	63	61	60	59	59	54	68
	Wylot	45	61	65	70	66	64	63	58	74
10	Wlot	37	52	58	58	56	56	57	60	66
	Wylot	39	56	63	65	63	61	61	59	70
11	Wlot	33	46	54	53	51	50	50	52	60
	Wylot	34	52	58	60	58	55	53	52	65
12	Wlot	31	41	51	49	48	47	47	42	56
	Wylot	33	49	53	57	54	51	50	45	61

Poziom mocy akustycznej [dB(A)]

Punkt pracy		63	125	250	500	1000	2000	4000	8000	L _{WA}
1	Wlot	44	66	76	74	85	78	71	75	87
	Wylot	47	75	77	86	90	85	76	77	93
2	Wlot	42	62	76	72	81	71	67	67	83
	Wylot	42	71	74	86	88	76	72	70	91
3	Wlot	41	60	77	69	69	70	67	63	79
	Wylot	43	70	73	83	78	73	74	68	85
4	Wlot	43	65	75	73	84	77	70	74	86
	Wylot	46	74	76	85	89	84	75	76	92
5	Wlot	41	61	75	71	80	70	66	66	82
	Wylot	41	70	73	85	87	75	71	69	89
6	Wlot	39	58	75	67	67	68	65	61	77
	Wylot	41	68	71	81	76	71	72	66	83
7	Wlot	42	64	74	72	83	76	69	73	85
	Wylot	45	73	75	84	88	83	74	75	91
8	Wlot	37	57	71	67	76	66	62	62	78
	Wylot	37	66	69	81	83	71	67	65	86
9	Wlot	33	52	69	61	61	62	59	55	71
	Wylot	35	62	65	75	70	65	66	60	77
10	Wlot	33	55	65	63	74	67	60	64	76
	Wylot	36	64	66	75	79	74	65	66	82
11	Wlot	25	45	59	55	64	54	50	50	66
	Wylot	25	54	57	69	71	59	55	53	73
12	Wlot	20	39	56	48	48	49	46	42	59
	Wylot	22	49	52	62	57	52	53	47	65

CHARAKTERYSTYKI PRACY

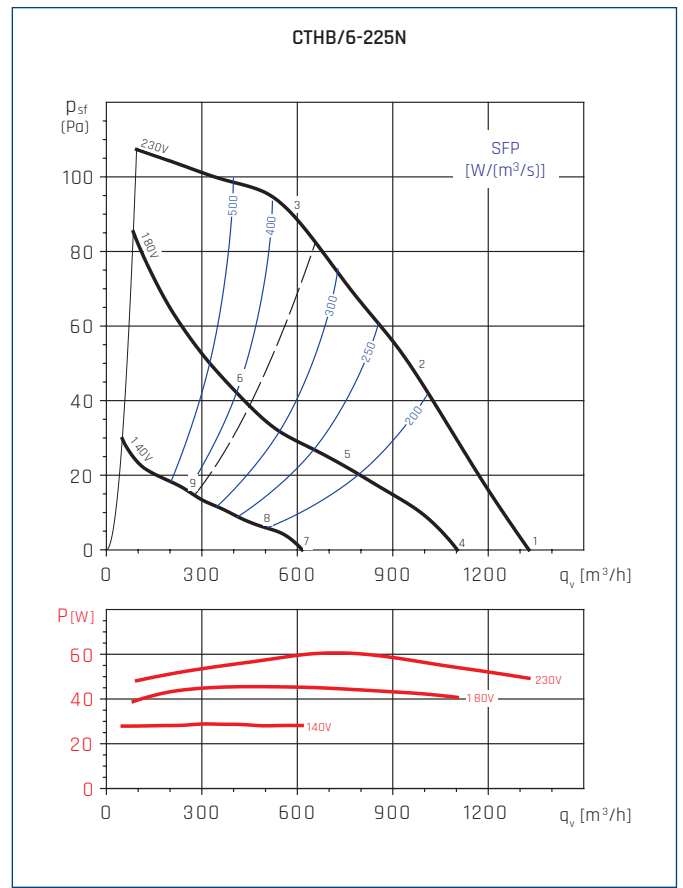
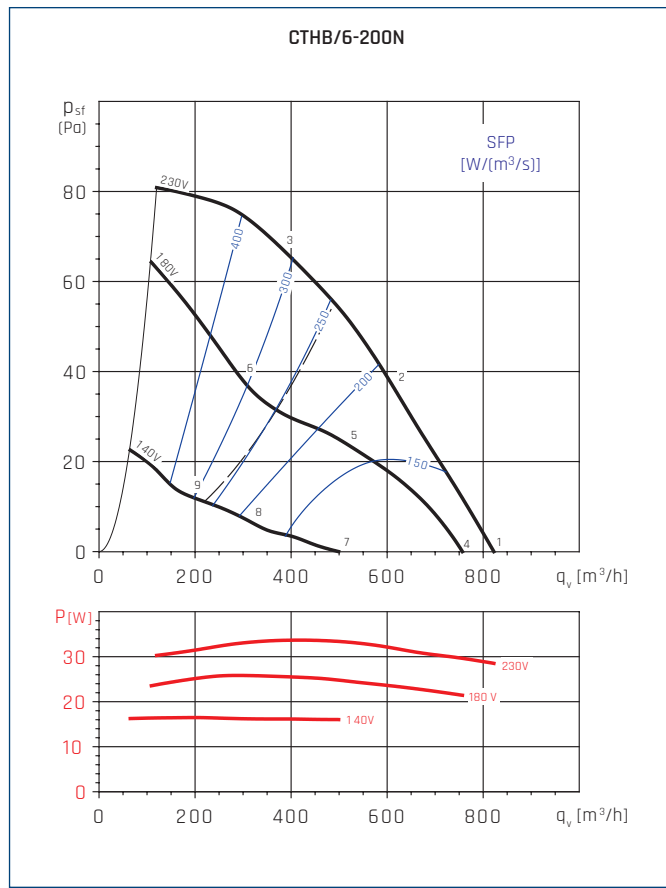

Poziom mocy akustycznej [dB(A)]

Punkt pracy		63	125	250	500	1000	2000	4000	8000	L _{WA}
1	Wlot	28	42	48	51	49	59	42	32	61
	Wylot	32	45	51	56	56	59	45	35	63
2	Wlot	33	42	49	50	48	50	42	32	56
	Wylot	35	44	51	54	55	53	45	36	60
3	Wlot	35	41	49	50	48	47	43	33	55
	Wylot	36	43	50	54	55	53	45	36	60
4	Wlot	27	41	46	49	47	58	40	30	59
	Wylot	30	43	49	54	54	58	43	33	61
5	Wlot	28	37	43	44	42	45	36	27	50
	Wylot	29	38	45	49	49	48	40	30	54
6	Wlot	30	36	44	44	43	42	38	28	50
	Wylot	31	38	45	49	50	48	40	31	55
7	Wlot	17	31	37	40	38	48	30	20	49
	Wylot	21	34	40	45	45	48	34	23	51
8	Wlot	16	25	32	32	30	33	25	15	38
	Wylot	18	26	33	37	37	36	28	18	42
9	Wlot	18	24	32	33	31	30	26	16	38
	Wylot	20	26	33	38	38	36	29	19	43

Poziom mocy akustycznej [dB(A)]

Punkt pracy		63	125	250	500	1000	2000	4000	8000	L _{WA}
1	Wlot	41	47	52	53	49	59	56	33	62
	Wylot	42	51	55	57	58	61	57	39	65
2	Wlot	39	44	49	51	47	52	47	30	57
	Wylot	40	47	51	55	56	54	49	35	61
3	Wlot	34	41	47	47	44	47	41	31	53
	Wylot	37	42	47	51	53	52	45	36	58
4	Wlot	37	44	49	50	46	56	53	30	59
	Wylot	39	48	51	54	55	57	54	36	62
5	Wlot	32	37	42	44	40	45	40	23	50
	Wylot	33	40	44	48	49	47	42	28	54
6	Wlot	26	34	39	39	36	39	33	23	45
	Wylot	29	34	39	43	45	44	37	28	50
7	Wlot	25	31	37	37	33	44	40	17	47
	Wylot	26	35	39	41	42	45	42	23	49
8	Wlot	21	26	31	33	29	34	29	12	39
	Wylot	22	29	33	37	38	36	31	17	43
9	Wlot	16	23	29	29	26	29	23	12	35
	Wylot	19	24	29	33	35	34	27	18	39

CHARAKTERYSTYKI PRACY

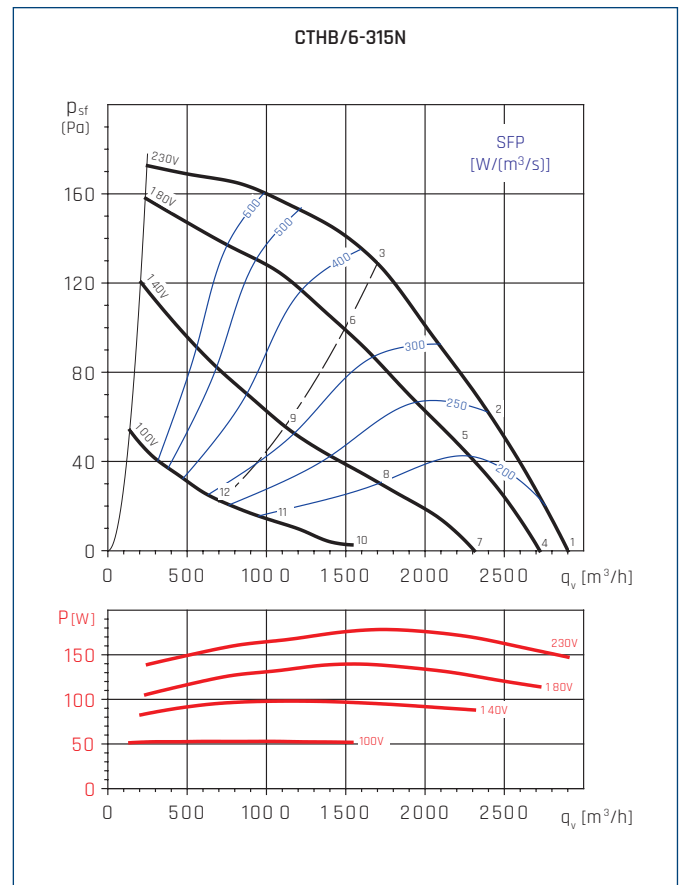
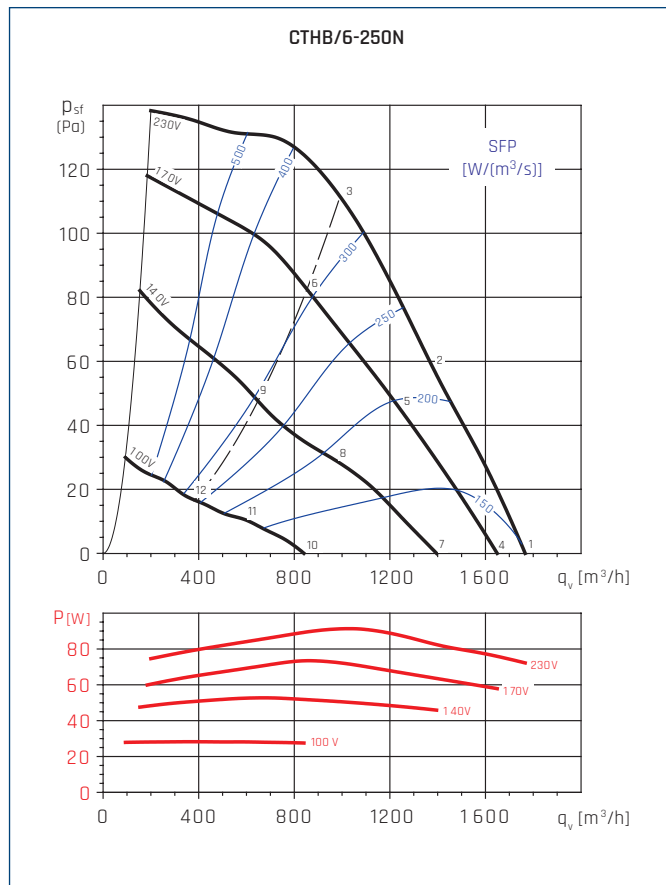

Poziom mocy akustycznej [dB(A)]

Punkt pracy		63	125	250	500	1000	2000	4000	8000	L _{WA}
1	Wlot	44	50	55	54	53	57	59	35	64
	Wylot	46	54	59	61	63	61	58	42	68
2	Wlot	43	48	53	52	51	53	52	32	60
	Wylot	45	51	56	58	59	55	50	35	64
3	Wlot	44	47	52	51	52	50	48	34	58
	Wylot	43	49	55	58	59	56	49	39	64
4	Wlot	43	49	54	53	52	56	58	34	62
	Wylot	45	53	58	60	61	60	57	41	67
5	Wlot	41	46	50	49	49	50	50	30	57
	Wylot	43	48	54	56	57	53	48	32	62
6	Wlot	41	43	49	48	49	47	44	31	55
	Wylot	40	45	51	55	56	52	45	35	60
7	Wlot	40	46	51	50	49	53	55	31	59
	Wylot	42	50	55	57	59	57	54	38	64
8	Wlot	34	39	43	42	42	43	43	23	50
	Wylot	36	41	47	49	50	46	41	25	55
9	Wlot	34	37	42	41	42	40	38	24	49
	Wylot	33	39	45	48	49	46	39	29	54
10	Wlot	29	36	41	39	38	42	44	20	49
	Wylot	31	39	45	47	48	46	44	27	53
11	Wlot	25	30	34	33	32	34	34	14	41
	Wylot	27	32	37	40	41	37	32	16	46
12	Wlot	23	25	31	30	30	29	26	13	37
	Wylot	22	27	33	37	37	34	27	17	42

Poziom mocy akustycznej [dB(A)]

Punkt pracy		63	125	250	500	1000	2000	4000	8000	L _{WA}
1	Wlot	44	54	60	59	59	61	64	45	68
	Wylot	47	58	64	66	65	66	64	50	72
2	Wlot	45	54	60	59	58	60	61	44	67
	Wylot	48	56	63	65	65	63	62	50	71
3	Wlot	44	52	57	55	56	58	56	43	64
	Wylot	46	53	60	62	62	61	58	48	68
4	Wlot	43	53	60	59	58	61	64	45	68
	Wylot	46	57	64	66	65	65	64	50	72
5	Wlot	43	52	58	57	56	57	59	42	65
	Wylot	45	54	61	63	62	61	60	48	69
6	Wlot	41	49	54	53	54	56	54	40	61
	Wylot	44	50	57	59	59	58	55	45	65
7	Wlot	40	50	56	56	55	57	60	41	64
	Wylot	43	54	60	62	61	62	60	46	68
8	Wlot	38	47	53	51	51	52	54	37	60
	Wylot	40	49	56	58	57	56	55	42	64
9	Wlot	35	43	48	47	48	50	47	34	55
	Wylot	37	44	51	53	53	52	49	39	59
10	Wlot	30	40	47	46	45	48	51	32	55
	Wylot	33	44	51	53	52	52	51	37	59
11	Wlot	28	37	43	41	41	42	44	26	50
	Wylot	30	39	46	48	47	46	45	32	54
12	Wlot	24	32	37	36	37	39	37	23	45
	Wylot	27	33	41	43	42	41	38	28	48

CHARAKTERYSTYKI PRACY

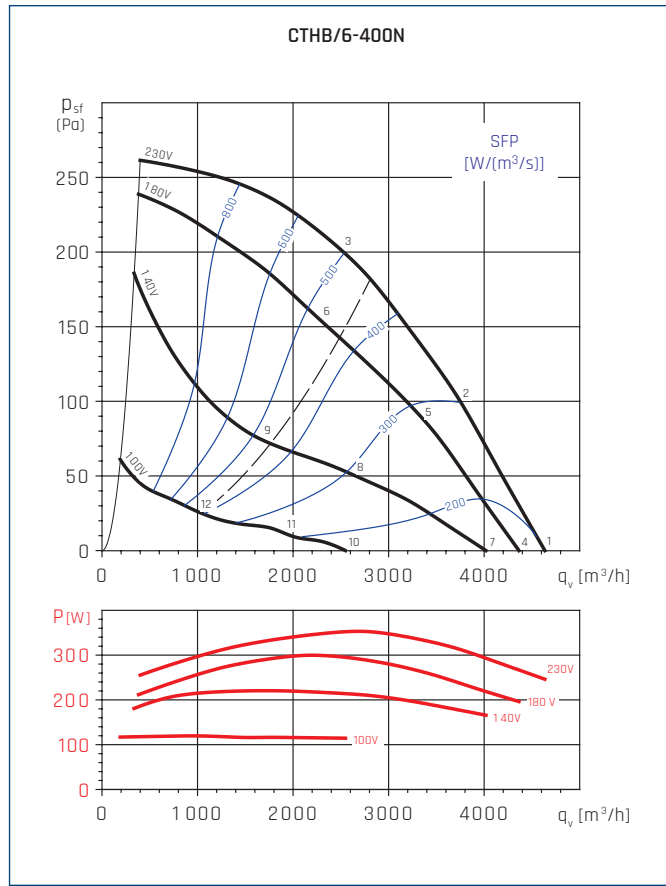

Poziom mocy akustycznej [dB(A)]

Punkt pracy		63	125	250	500	1000	2000	4000	8000	L _{WA}
1	Wlot	43	53	63	67	72	62	71	53	76
	Wylot	45	60	68	76	81	66	72	56	83
2	Wlot	43	53	61	67	66	60	67	50	72
	Wylot	46	57	68	75	74	64	66	53	78
3	Wlot	44	55	61	60	59	60	60	49	67
	Wylot	49	56	65	68	64	64	63	53	72
4	Wlot	42	52	62	66	71	61	70	52	75
	Wylot	44	59	67	75	80	65	71	55	82
5	Wlot	42	52	60	66	65	59	66	49	71
	Wylot	45	56	67	74	73	63	65	52	77
6	Wlot	42	53	59	58	57	58	58	47	65
	Wylot	47	54	63	66	62	62	61	51	70
7	Wlot	40	50	60	64	69	59	68	50	73
	Wylot	42	57	65	73	78	63	69	53	80
8	Wlot	36	46	54	60	59	53	60	43	65
	Wylot	39	50	61	68	67	57	59	46	71
9	Wlot	34	45	51	50	49	50	50	39	57
	Wylot	39	46	55	58	54	54	53	43	62
10	Wlot	30	40	50	54	59	49	58	40	63
	Wylot	32	47	55	63	68	53	59	43	70
11	Wlot	24	34	42	48	47	41	48	31	53
	Wylot	27	38	49	56	55	45	47	34	59
12	Wlot	23	34	40	39	38	39	39	28	46
	Wylot	28	35	44	47	43	43	42	32	51

CHARAKTERYSTYKI PRACY

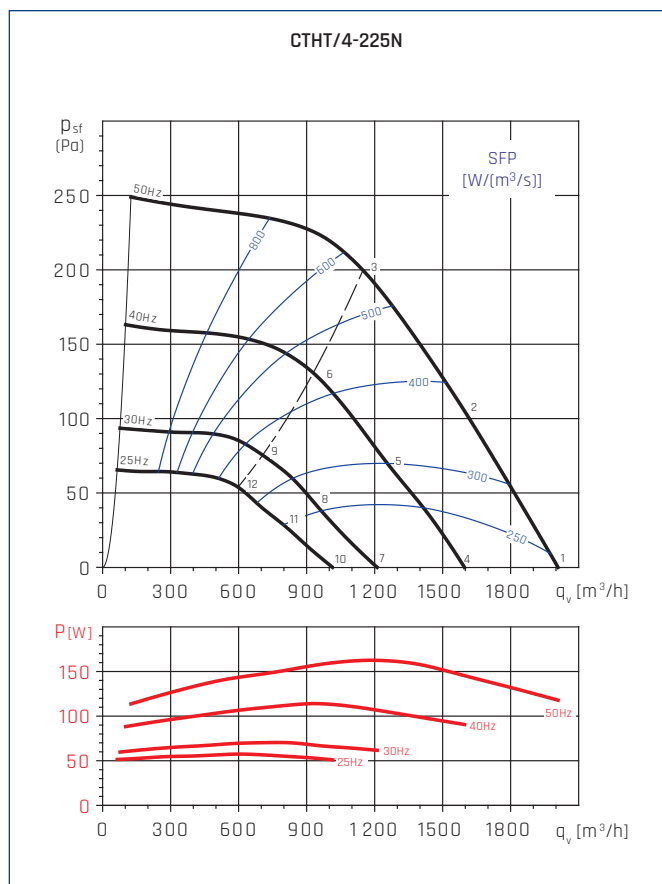
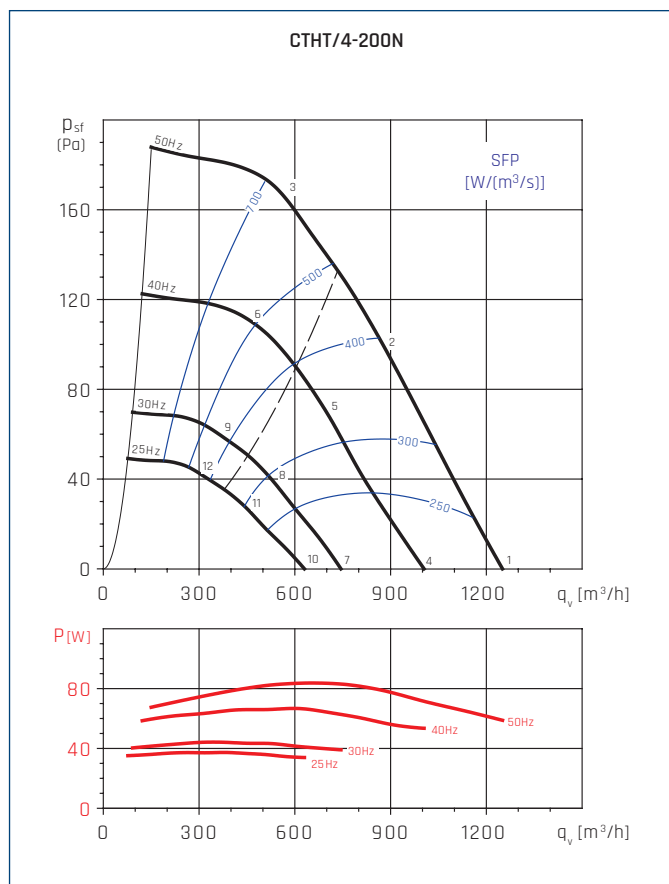

Poziom mocy akustycznej [dB(A)]

Punkt pracy		63	125	250	500	1000	2000	4000	8000	L _{WA}
1	Wlot	32	49	57	59	57	58	64	45	67
	Wylot	34	57	60	65	65	64	65	51	71
2	Wlot	34	52	58	60	56	57	56	45	65
	Wylot	36	54	60	65	64	63	59	49	70
3	Wlot	36	50	57	60	56	57	56	46	65
	Wylot	38	52	60	64	64	63	59	50	70
4	Wlot	28	44	52	55	53	53	60	41	63
	Wylot	30	52	55	60	61	59	60	46	67
5	Wlot	30	47	54	56	52	52	52	40	61
	Wylot	31	50	56	60	60	58	54	45	65
6	Wlot	32	45	53	56	52	53	51	41	60
	Wylot	33	48	55	60	60	59	54	46	65
7	Wlot	22	38	46	48	47	47	53	35	56
	Wylot	23	46	49	54	55	53	54	40	60
8	Wlot	24	41	48	50	46	46	46	34	55
	Wylot	25	44	50	54	54	52	48	39	59
9	Wlot	26	40	47	50	46	47	45	35	55
	Wylot	27	42	49	54	54	53	48	40	59
10	Wlot	18	34	42	45	43	43	50	31	53
	Wylot	20	42	45	50	51	49	50	36	57
11	Wlot	20	37	44	46	42	43	42	30	51
	Wylot	21	40	46	50	50	49	45	35	56
12	Wlot	22	36	43	46	42	43	42	31	51
	Wylot	24	38	45	50	50	49	45	36	56

Poziom mocy akustycznej [dB(A)]

Punkt pracy		63	125	250	500	1000	2000	4000	8000	L _{WA}
1	Wlot	42	63	65	65	60	63	68	53	73
	Wylot	46	63	67	71	70	68	70	58	77
2	Wlot	44	57	63	63	58	60	61	45	69
	Wylot	44	59	63	67	67	65	63	50	73
3	Wlot	42	55	60	61	57	58	57	45	66
	Wylot	41	57	61	65	66	63	60	50	71
4	Wlot	37	58	60	60	55	58	63	48	68
	Wylot	41	58	62	66	65	63	65	53	72
5	Wlot	39	52	58	58	53	55	56	40	64
	Wylot	39	54	58	62	62	60	58	45	68
6	Wlot	38	51	56	57	53	54	53	41	62
	Wylot	37	53	57	61	62	59	56	46	66
7	Wlot	31	52	54	54	49	52	57	42	62
	Wylot	35	52	56	60	59	57	59	47	66
8	Wlot	34	47	53	53	48	50	51	35	58
	Wylot	34	49	53	57	57	55	53	40	62
9	Wlot	32	45	50	51	47	48	47	35	56
	Wylot	31	47	51	55	56	53	50	40	60
10	Wlot	28	49	51	51	46	49	54	39	58
	Wylot	32	49	53	57	56	54	56	44	62
11	Wlot	30	43	49	49	44	46	47	31	54
	Wylot	30	45	49	53	53	51	49	36	58
12	Wlot	28	41	46	47	43	44	43	31	52
	Wylot	27	43	47	51	52	49	46	36	57

CHARAKTERYSTYKI PRACY

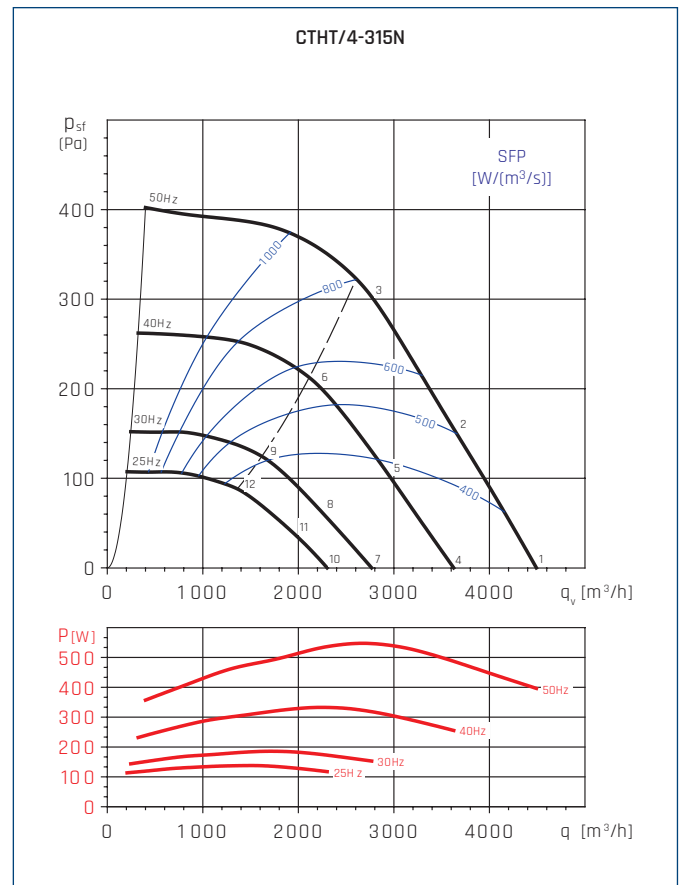
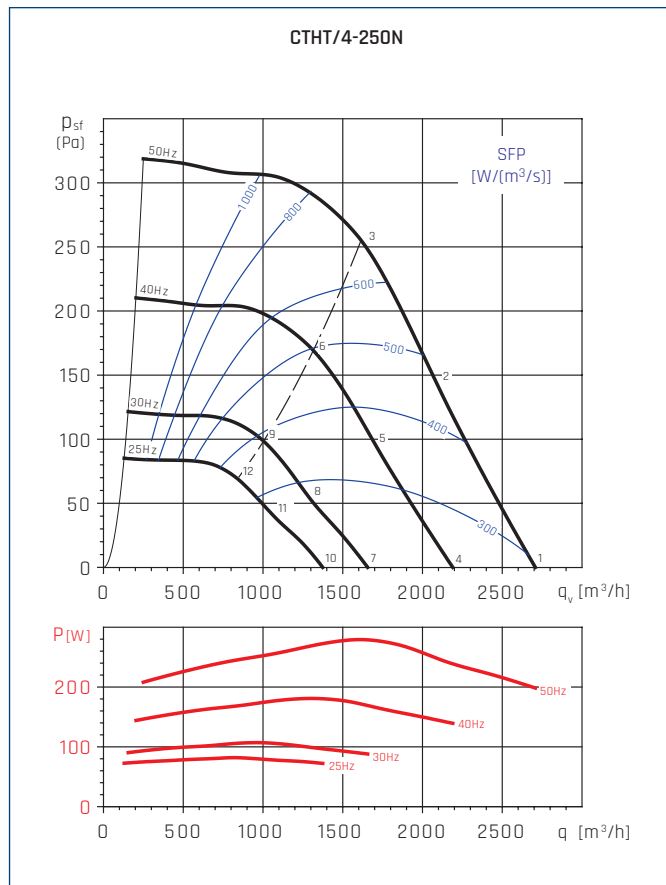

Poziom mocy akustycznej [dB(A)]

Punkt pracy		63	125	250	500	1000	2000	4000	8000	L_{WA}
1	Wlot	45	61	66	68	62	64	67	57	73
	Wylot	47	65	71	74	72	70	68	61	79
2	Wlot	46	59	63	65	61	63	59	47	70
	Wylot	47	63	68	70	70	69	61	52	76
3	Wlot	43	57	62	64	62	61	55	50	69
	Wylot	44	61	66	70	70	67	61	54	75
4	Wlot	40	57	62	63	58	59	63	53	69
	Wylot	42	61	67	69	67	66	64	56	74
5	Wlot	42	54	59	60	56	59	54	43	66
	Wylot	43	58	63	66	65	65	57	48	71
6	Wlot	39	53	58	60	57	56	51	45	64
	Wylot	39	57	62	65	65	63	56	49	70
7	Wlot	34	51	56	57	52	53	57	47	63
	Wylot	36	55	60	63	61	60	58	50	68
8	Wlot	36	49	53	54	50	53	48	37	60
	Wylot	37	52	58	60	59	59	51	42	65
9	Wlot	33	47	52	54	51	51	45	39	59
	Wylot	34	51	56	59	59	57	51	43	65
10	Wlot	30	47	52	53	48	50	53	43	59
	Wylot	32	51	57	59	58	56	54	46	64
11	Wlot	32	45	49	51	47	49	45	33	56
	Wylot	33	49	54	56	55	55	47	38	62
12	Wlot	29	43	48	50	48	47	41	36	55
	Wylot	30	47	52	56	56	53	47	40	61

Poziom mocy akustycznej [dB(A)]

Punkt pracy		63	125	250	500	1000	2000	4000	8000	L_{WA}
1	Wlot	51	66	71	72	70	70	71	74	79
	Wylot	52	70	77	79	77	75	75	73	84
2	Wlot	51	64	72	71	69	68	68	69	78
	Wylot	52	70	75	77	76	73	71	70	83
3	Wlot	50	60	70	67	66	65	66	61	75
	Wylot	51	68	72	76	73	70	69	64	80
4	Wlot	46	62	67	67	66	65	66	69	75
	Wylot	48	65	72	75	73	70	70	68	80
5	Wlot	46	60	67	66	65	63	63	65	73
	Wylot	48	66	71	73	71	68	67	66	78
6	Wlot	46	55	65	63	62	61	62	57	70
	Wylot	47	63	68	72	68	66	65	60	76
7	Wlot	40	56	61	61	60	59	60	63	69
	Wylot	42	59	66	69	67	64	64	62	74
8	Wlot	40	54	62	60	59	57	57	59	67
	Wylot	42	60	65	67	65	62	61	60	72
9	Wlot	40	50	59	57	56	55	56	51	64
	Wylot	41	57	62	66	62	60	59	54	70
10	Wlot	36	52	57	57	56	55	56	59	65
	Wylot	38	55	62	65	63	60	60	59	70
11	Wlot	36	50	58	56	55	54	53	55	63
	Wylot	38	56	61	63	62	59	57	56	68
12	Wlot	36	46	56	53	52	51	52	47	61
	Wylot	37	54	58	62	59	56	55	50	66

CHARAKTERYSTYKI PRACY

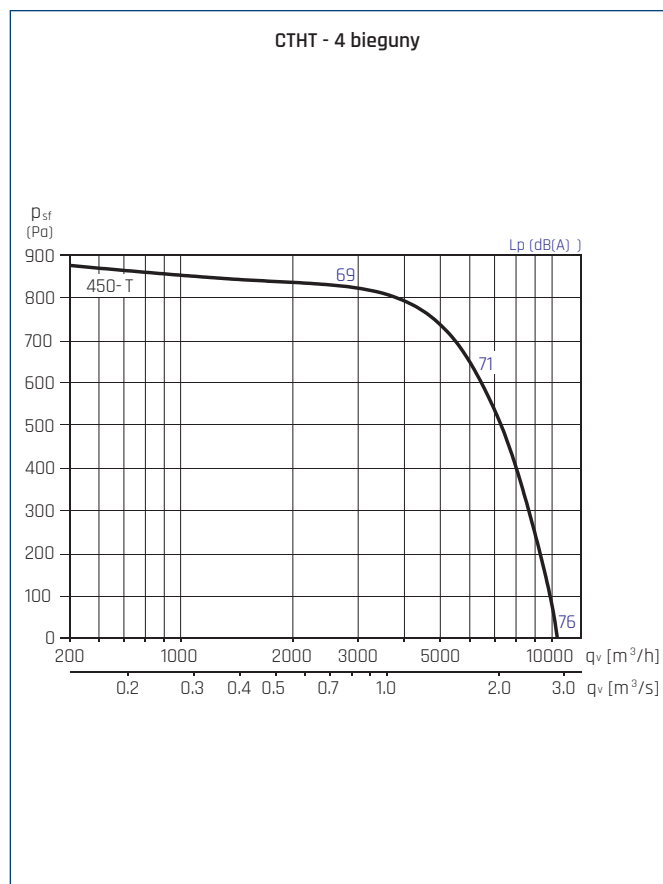
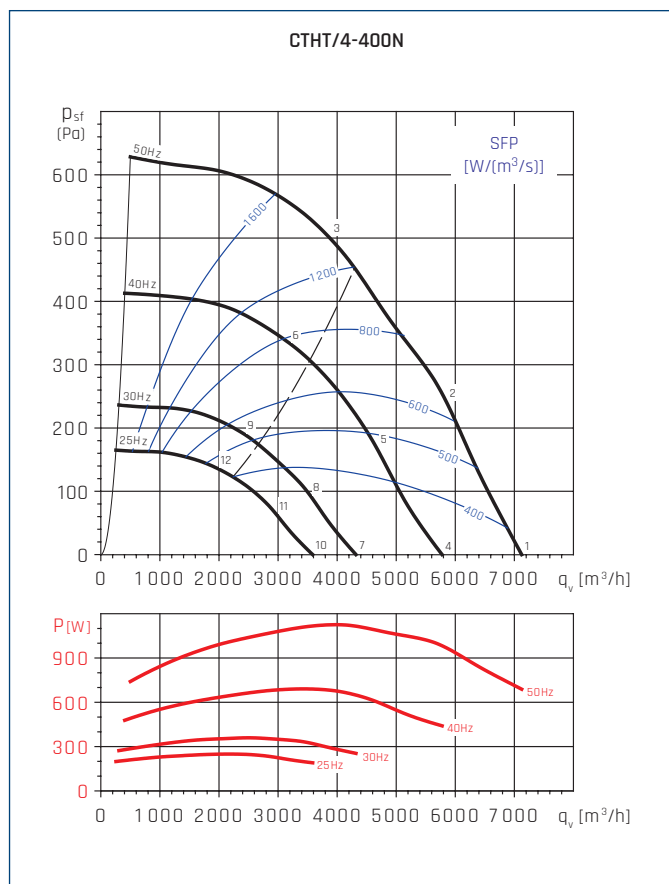

Poziom mocy akustycznej [dB(A)]

Punkt pracy		63	125	250	500	1000	2000	4000	8000	L_{WA}
1	Wlot	45	66	76	73	85	77	68	76	87
	Wylot	48	75	77	87	90	86	74	79	93
2	Wlot	42	64	76	72	80	70	66	66	82
	Wylot	42	72	75	87	88	76	72	70	91
3	Wlot	46	63	78	69	68	70	69	64	80
	Wylot	44	71	73	84	79	73	73	69	86
4	Wlot	40	61	71	68	80	72	63	71	82
	Wylot	43	70	72	82	85	81	69	74	89
5	Wlot	38	60	72	68	76	66	62	62	78
	Wylot	38	68	71	83	84	72	68	66	87
6	Wlot	42	59	74	65	64	66	65	60	76
	Wylot	40	67	69	80	75	69	69	65	82
7	Wlot	34	55	65	62	74	66	57	65	76
	Wylot	37	64	66	76	79	75	63	68	82
8	Wlot	32	54	66	62	70	60	56	56	72
	Wylot	32	62	65	77	78	66	62	60	81
9	Wlot	36	53	68	59	58	60	59	54	70
	Wylot	34	61	63	74	69	63	63	59	76
10	Wlot	30	51	61	58	70	62	53	61	72
	Wylot	33	60	62	72	75	71	59	64	79
11	Wlot	28	50	62	58	66	56	52	52	68
	Wylot	28	58	61	73	74	62	58	56	77
12	Wlot	32	49	64	55	54	56	55	50	66
	Wylot	30	57	59	70	65	59	59	55	72

CHARAKTERYSTYKI PRACY

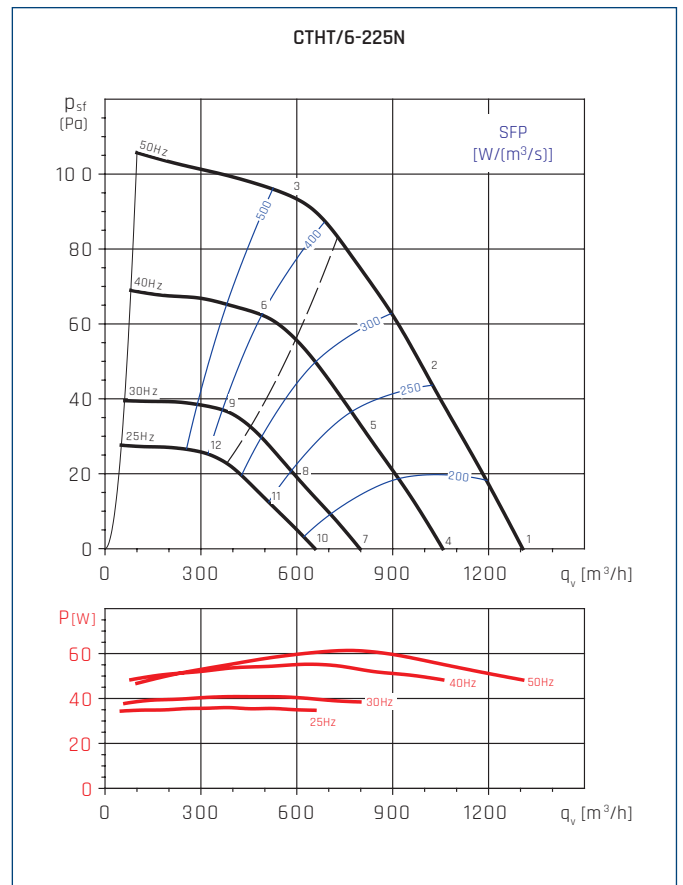
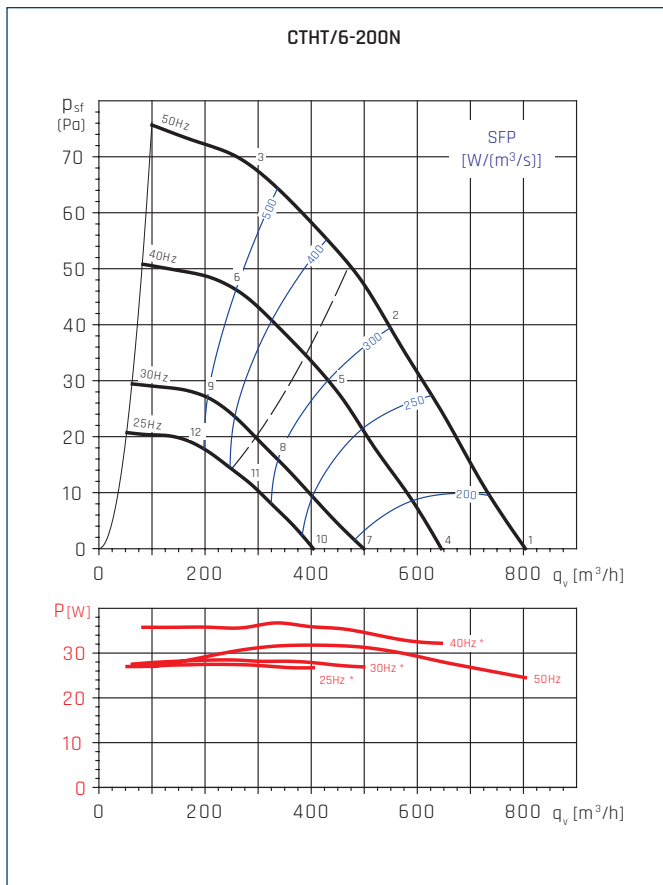

Poziom mocy akustycznej [dB(A)]

Punkt pracy		63	125	250	500	1000	2000	4000	8000	L_{WA}
1	Wlot	33	47	54	61	56	55	60	45	65
	Wylot	35	48	56	65	62	61	62	47	69
2	Wlot	34	47	53	60	55	54	53	44	63
	Wylot	34	45	55	62	61	60	54	46	66
3	Wlot	42	47	53	60	55	54	51	44	63
	Wylot	43	48	55	63	62	61	55	47	67
4	Wlot	31	45	52	59	54	52	58	43	63
	Wylot	33	46	54	63	60	59	60	45	67
5	Wlot	29	42	49	55	51	49	48	40	58
	Wylot	30	40	50	57	56	55	50	41	61
6	Wlot	38	43	48	56	51	50	47	40	59
	Wylot	39	43	51	59	57	57	51	42	63
7	Wlot	24	38	45	52	47	46	51	37	56
	Wylot	26	39	48	56	53	53	53	38	60
8	Wlot	20	34	40	46	42	40	39	31	49
	Wylot	21	31	41	48	47	46	41	32	53
9	Wlot	30	34	40	47	43	41	39	32	50
	Wylot	30	35	42	50	49	48	42	34	54
10	Wlot	10	24	31	37	32	31	36	22	42
	Wylot	12	24	33	42	39	38	39	24	46
11	Wlot	9	22	29	35	30	29	28	19	38
	Wylot	10	20	30	37	36	35	29	21	41
12	Wlot	19	23	29	36	32	30	28	21	39
	Wylot	19	24	32	39	38	37	31	23	44

Poziom mocy akustycznej [dB(A)]

Punkt pracy		63	125	250	500	1000	2000	4000	8000	L_{WA}
1	Wlot	41	47	52	53	49	59	56	33	62
	Wylot	42	51	55	57	58	60	57	39	65
2	Wlot	39	45	49	51	48	53	47	30	57
	Wylot	40	47	51	55	56	54	49	36	61
3	Wlot	34	42	47	47	45	48	41	31	53
	Wylot	38	43	47	51	53	53	45	36	58
4	Wlot	36	43	48	48	44	55	51	30	58
	Wylot	37	47	50	53	53	56	53	34	61
5	Wlot	35	40	45	46	43	48	43	30	53
	Wylot	36	43	47	50	52	50	45	31	57
6	Wlot	30	37	43	43	40	43	37	30	49
	Wylot	33	38	43	47	49	48	41	32	54
7	Wlot	30	37	42	42	38	49	45	30	52
	Wylot	31	41	44	47	47	50	47	30	55
8	Wlot	30	34	39	41	37	42	37	30	47
	Wylot	30	37	41	45	46	44	39	30	51
9	Wlot	30	32	37	37	34	37	31	30	44
	Wylot	30	32	37	41	43	43	35	30	48
10	Wlot	30	33	38	38	34	45	41	30	48
	Wylot	30	37	40	43	43	46	43	30	51
11	Wlot	35	40	45	46	43	48	43	35	53
	Wylot	36	42	47	50	51	50	44	35	56
12	Wlot	35	37	42	42	40	43	37	35	49
	Wylot	35	38	43	46	48	48	40	35	53

CHARAKTERYSTYKI PRACY

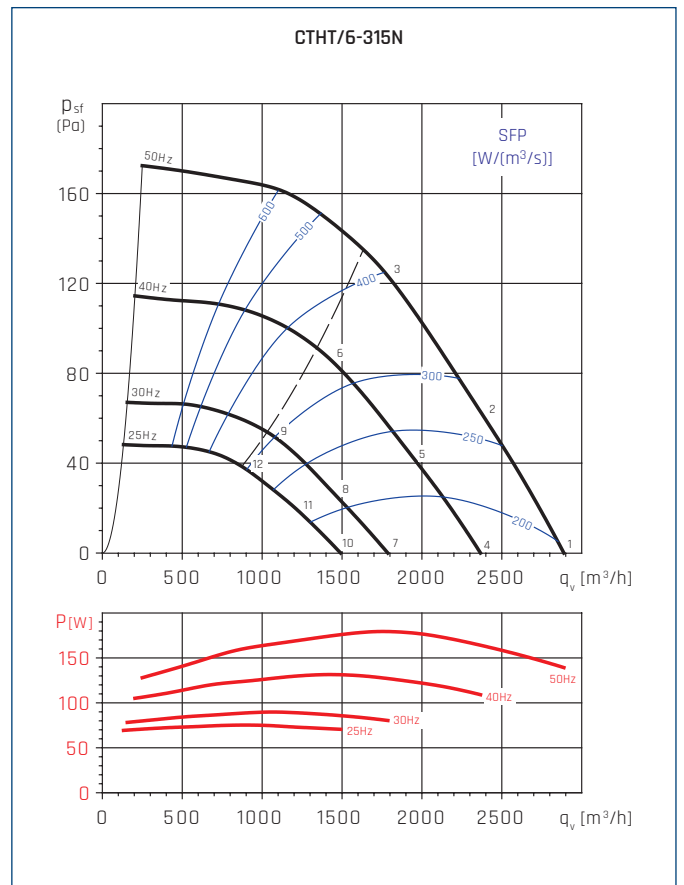
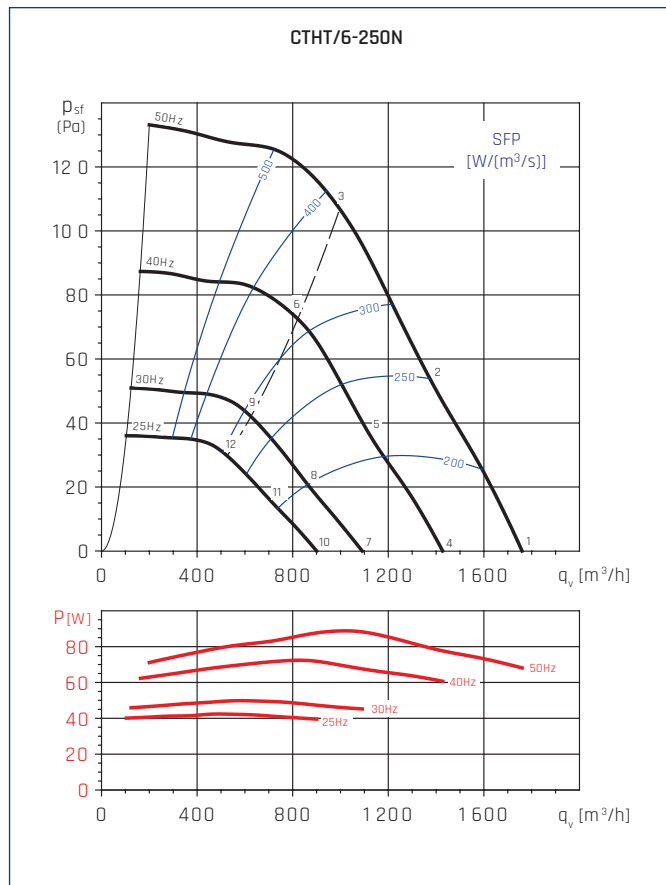

Poziom mocy akustycznej [dB(A)]

Punkt pracy		63	125	250	500	1000	2000	4000	8000	L_{WA}
1	Wlot	43	50	55	53	52	56	58	34	63
	Wylot	45	53	59	61	62	60	58	42	67
2	Wlot	43	48	52	51	50	52	52	31	59
	Wylot	45	50	55	58	59	55	50	34	63
3	Wlot	44	46	52	51	51	50	47	34	58
	Wylot	43	48	54	58	58	55	48	38	63
4	Wlot	39	45	50	49	48	52	54	30	58
	Wylot	41	49	54	56	57	56	53	37	63
5	Wlot	38	43	48	47	46	48	47	27	55
	Wylot	40	46	51	53	55	50	45	30	59
6	Wlot	39	42	47	47	47	45	43	29	54
	Wylot	38	44	50	53	54	51	44	34	59
7	Wlot	33	39	44	43	42	46	48	24	52
	Wylot	35	43	48	50	52	50	47	31	57
8	Wlot	33	38	42	41	40	42	42	21	49
	Wylot	35	40	45	48	49	45	40	24	53
9	Wlot	34	36	42	41	41	40	37	24	48
	Wylot	33	38	44	48	48	45	38	28	53
10	Wlot	29	36	41	39	38	42	44	20	49
	Wylot	31	39	45	47	48	46	44	27	53
11	Wlot	29	34	38	37	36	38	38	17	45
	Wylot	31	36	41	44	45	41	36	20	50
12	Wlot	30	33	38	37	38	36	34	20	44
	Wylot	29	34	41	44	45	42	35	24	49

Poziom mocy akustycznej [dB(A)]

Punkt pracy		63	125	250	500	1000	2000	4000	8000	L_{WA}
1	Wlot	45	55	61	60	60	62	65	46	69
	Wylot	48	59	65	67	66	67	65	51	73
2	Wlot	45	54	60	59	58	59	61	44	67
	Wylot	47	56	63	65	65	63	62	50	71
3	Wlot	44	52	57	56	57	59	56	43	64
	Wylot	47	53	60	62	62	61	58	48	68
4	Wlot	40	50	57	56	55	57	61	42	65
	Wylot	43	54	60	63	62	62	61	47	69
5	Wlot	41	49	56	54	54	55	57	39	63
	Wylot	43	52	59	61	60	59	57	45	67
6	Wlot	40	48	53	51	52	54	52	39	60
	Wylot	42	49	56	58	58	57	54	44	64
7	Wlot	34	44	51	50	49	52	55	36	59
	Wylot	37	48	55	57	56	56	55	41	63
8	Wlot	35	44	50	48	48	49	51	34	57
	Wylot	37	46	53	55	54	53	52	39	61
9	Wlot	34	42	47	46	47	49	46	33	54
	Wylot	36	43	50	52	52	51	48	38	58
10	Wlot	31	40	47	46	45	48	51	32	55
	Wylot	34	44	51	53	52	53	51	37	59
11	Wlot	31	40	46	45	44	46	47	30	53
	Wylot	34	43	49	51	51	49	48	36	57
12	Wlot	30	38	43	42	43	45	43	29	50
	Wylot	33	39	47	48	48	47	44	34	54

CHARAKTERYSTYKI PRACY

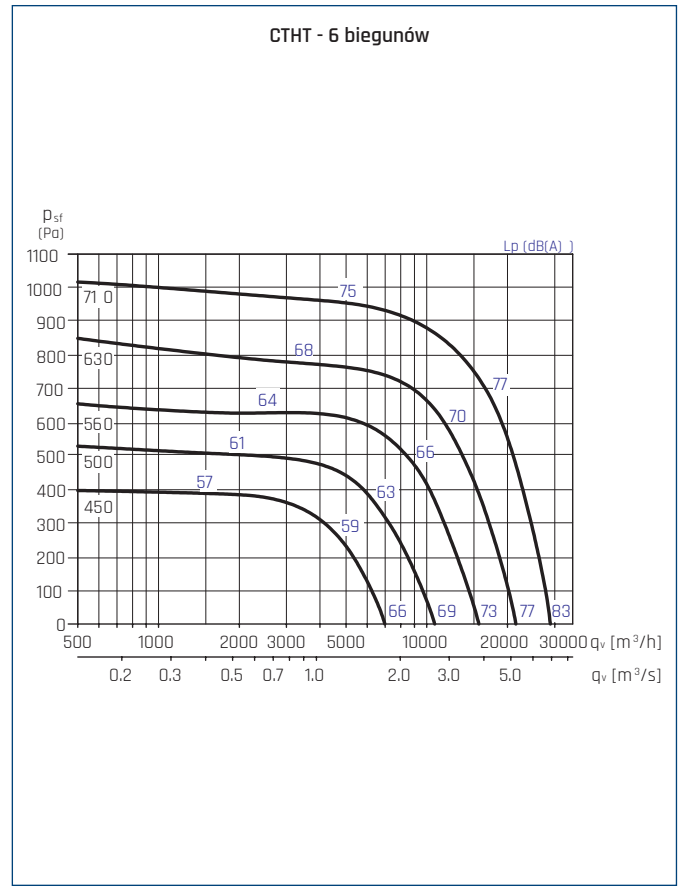
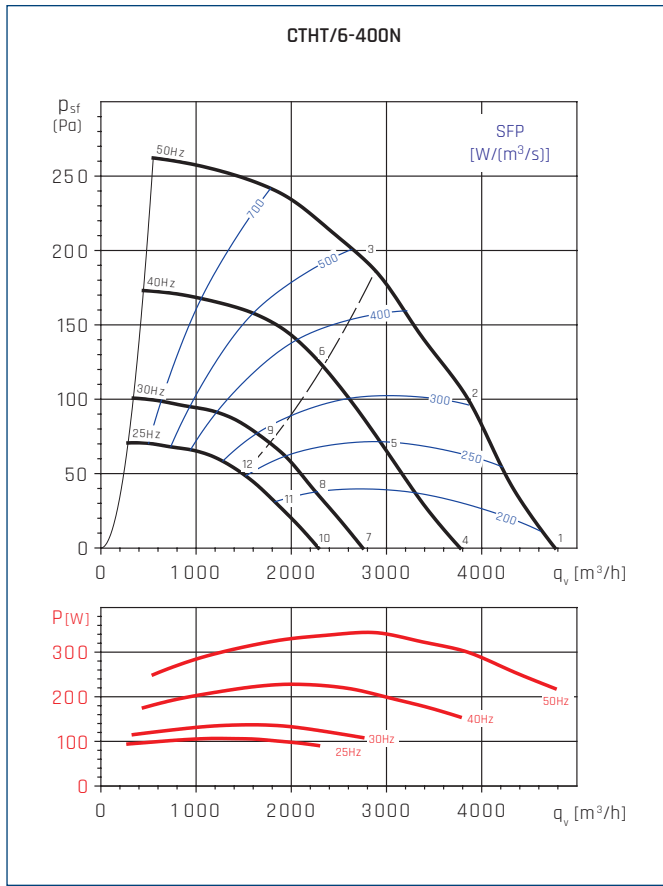

Poziom mocy akustycznej [dB(A)]

Punkt pracy		63	125	250	500	1000	2000	4000	8000	L_{WA}
1	Wlot	41	53	63	67	73	62	71	56	76
	Wylot	44	61	69	76	81	67	72	59	83
2	Wlot	40	52	63	67	67	60	66	50	72
	Wylot	43	58	68	75	75	65	67	54	79
3	Wlot	38	52	61	62	59	59	61	49	68
	Wylot	45	56	66	69	65	65	64	54	73
4	Wlot	36	48	58	62	68	57	66	51	72
	Wylot	39	56	64	71	76	62	67	54	78
5	Wlot	36	48	59	63	63	56	62	46	68
	Wylot	39	54	64	71	71	61	63	50	75
6	Wlot	34	48	57	58	55	55	57	45	63
	Wylot	41	52	62	65	61	61	60	50	69
7	Wlot	30	42	52	56	62	51	60	45	66
	Wylot	33	50	58	65	70	56	61	48	72
8	Wlot	30	42	53	57	57	50	56	40	62
	Wylot	33	48	58	65	65	55	57	44	69
9	Wlot	28	42	51	52	49	49	51	39	57
	Wylot	35	46	56	59	55	55	54	44	63
10	Wlot	26	38	48	52	58	47	56	41	62
	Wylot	29	46	54	61	66	52	57	44	68
11	Wlot	26	38	49	53	53	46	52	36	58
	Wylot	29	44	54	61	61	51	53	40	65
12	Wlot	24	38	47	48	45	45	47	35	54
	Wylot	31	42	52	55	51	51	50	40	59

CHARAKTERYSTYKI PRACY

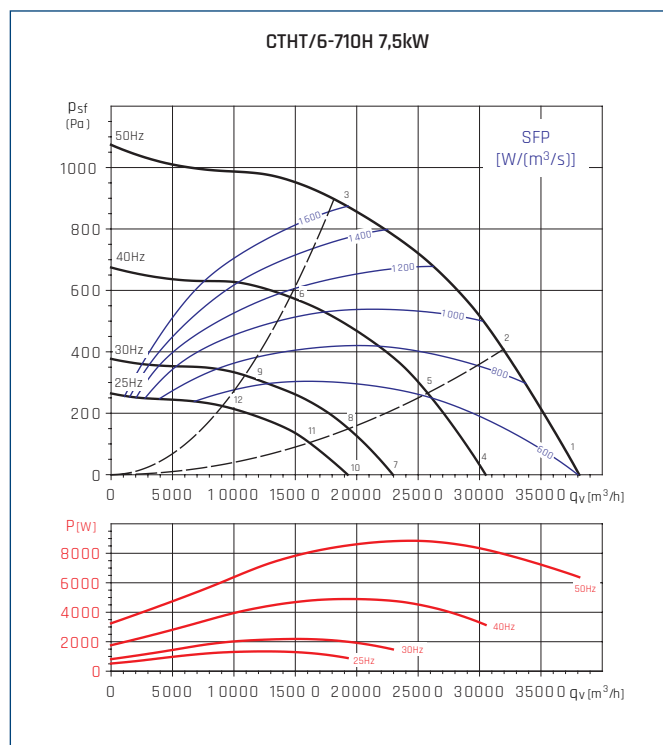
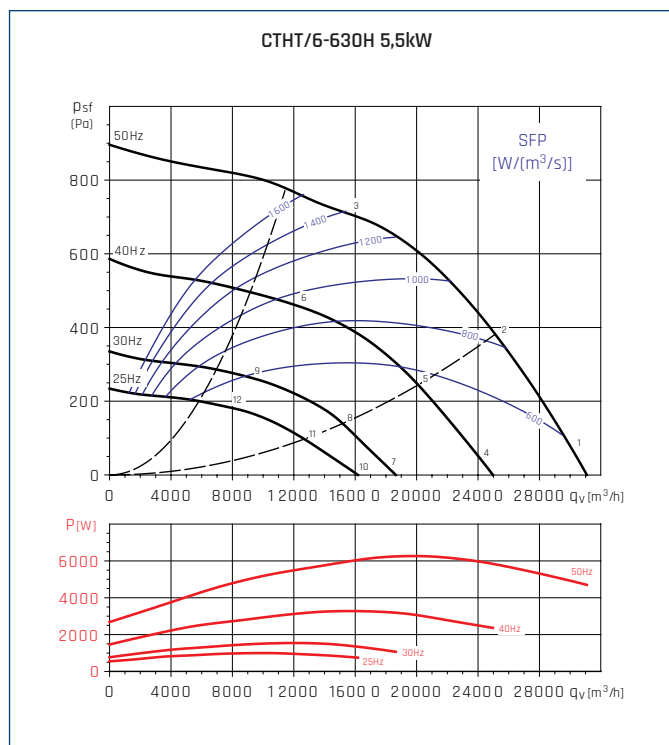

Poziom mocy akustycznej [dB(A)]

Punkt pracy		63	125	250	500	1000	2000	4000	8000	L _{WA}
1	Wylot	66	85	90	90	92	89	85	79	97
2	Wylot	63	82	87	87	89	87	81	75	94
3	Wylot	69	80	85	85	87	83	84	79	92
4	Wylot	61	80	85	85	87	84	80	74	92
5	Wylot	58	77	82	82	84	82	76	70	89
6	Wylot	64	75	80	80	82	78	79	74	88
7	Wylot	55	74	79	79	81	78	74	68	86
8	Wylot	52	71	76	76	78	76	70	64	83
9	Wylot	58	69	74	74	76	72	73	68	81
10	Wylot	51	70	75	75	77	74	70	64	82
11	Wylot	48	67	72	72	74	72	66	60	79
12	Wylot	54	65	70	70	72	68	69	64	77

Poziom mocy akustycznej [dB(A)]

Punkt pracy		63	125	250	500	1000	2000	4000	8000	L _{WA}
1	Wylot	82	86	92	92	95	89	87	77	99
2	Wylot	79	83	89	89	90	86	85	75	96
3	Wylot	77	81	88	88	90	83	84	72	94
4	Wylot	76	80	86	86	89	83	81	71	93
5	Wylot	74	78	84	84	85	81	80	70	90
6	Wylot	71	75	82	82	84	77	78	66	89
7	Wylot	67	71	77	77	80	74	72	62	84
8	Wylot	66	70	76	76	77	73	72	62	83
9	Wylot	64	68	75	75	77	70	71	59	82
10	Wylot	62	66	72	72	75	69	67	57	79
11	Wylot	61	65	71	71	72	68	67	57	77
12	Wylot	59	63	70	70	72	65	66	54	76

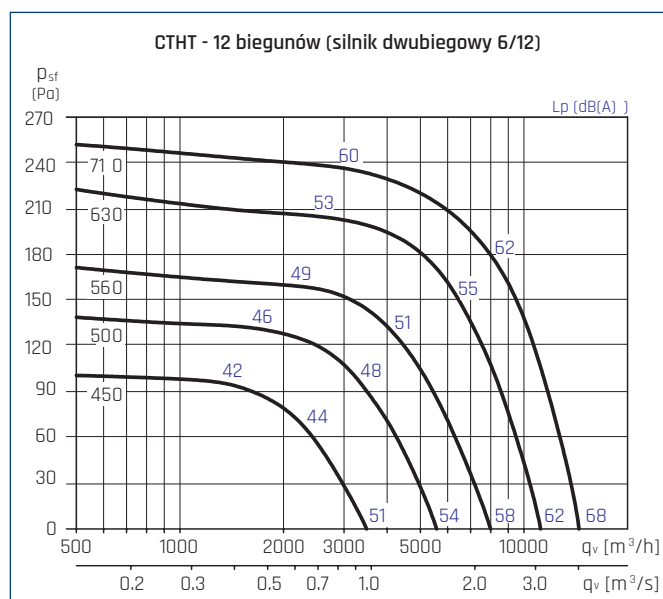
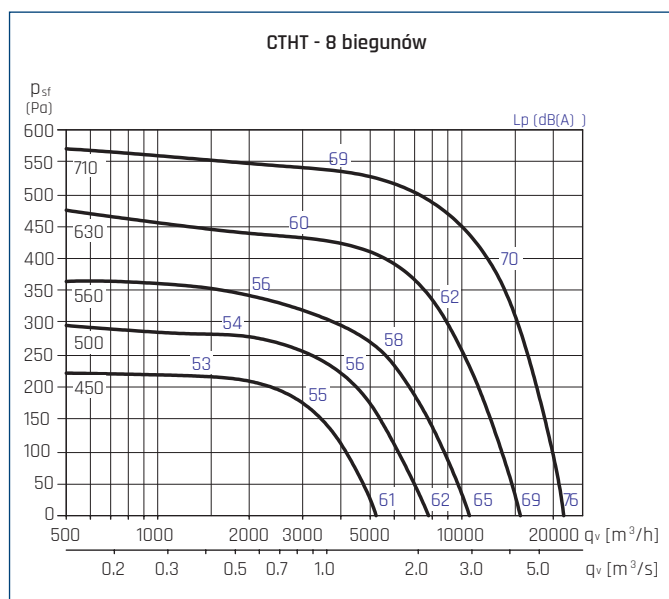

CHARAKTERYSTYKI PRACY

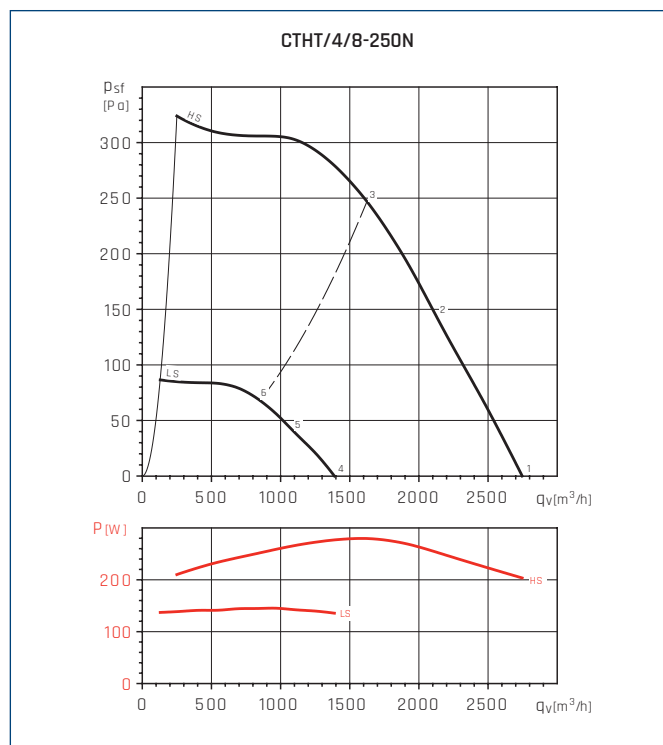
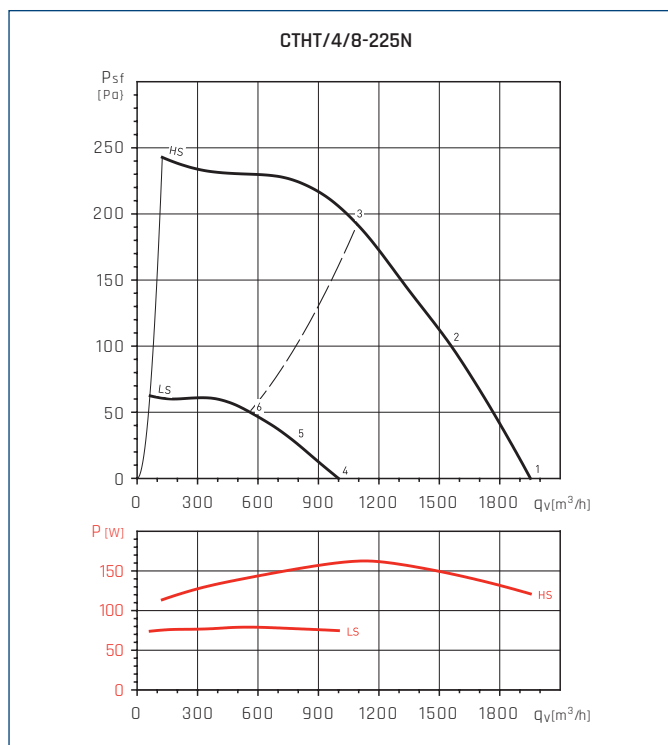

Poziom mocy akustycznej [dB(A)]

Punkt pracy		63	125	250	500	1000	2000	4000	8000	L_{WA}
1	Wlot	42	63	65	65	60	63	68	53	72
	Wylot	46	63	67	71	70	68	70	58	76
2	Wlot	44	57	63	63	58	60	61	45	68
	Wylot	44	59	63	67	67	65	63	50	72
3	Wlot	42	55	60	61	57	58	57	45	66
	Wylot	41	57	61	65	66	63	60	50	70
4	Wlot	27	48	50	50	45	48	53	38	58
	Wylot	31	48	52	56	55	53	55	43	62
5	Wlot	29	42	48	48	43	45	46	30	54
	Wylot	29	44	48	52	52	50	48	35	58
6	Wlot	27	40	45	46	42	43	42	30	52
	Wylot	26	42	46	50	51	48	45	35	56

Poziom mocy akustycznej [dB(A)]

Punkt pracy		63	125	250	500	1000	2000	4000	8000	L_{WA}
1	Wlot	45	61	66	68	62	64	67	57	73
	Wylot	47	65	71	74	72	70	68	61	79
2	Wlot	46	59	63	65	61	63	59	47	70
	Wylot	47	63	68	70	69	69	61	52	76
3	Wlot	43	57	62	64	62	61	55	50	69
	Wylot	44	61	66	70	70	67	61	54	75
4	Wlot	30	47	52	53	48	50	53	43	59
	Wylot	32	51	57	59	58	56	54	47	64
5	Wlot	32	45	49	51	47	49	45	33	56
	Wylot	33	49	54	56	56	55	47	38	62
6	Wlot	29	43	48	50	48	47	42	36	55
	Wylot	30	47	52	56	56	53	47	40	61

CHARAKTERYSTYKI PRACY

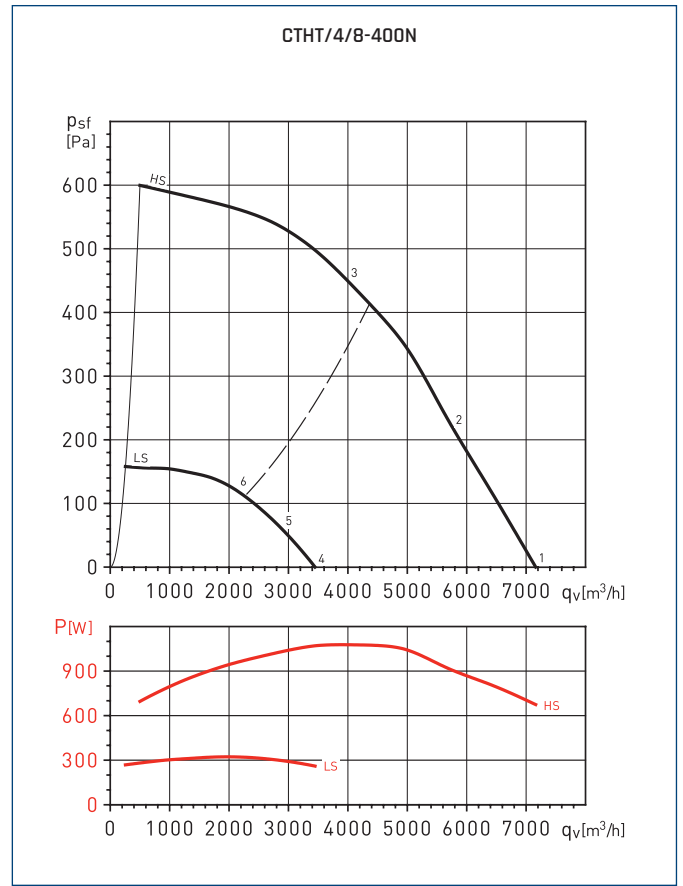
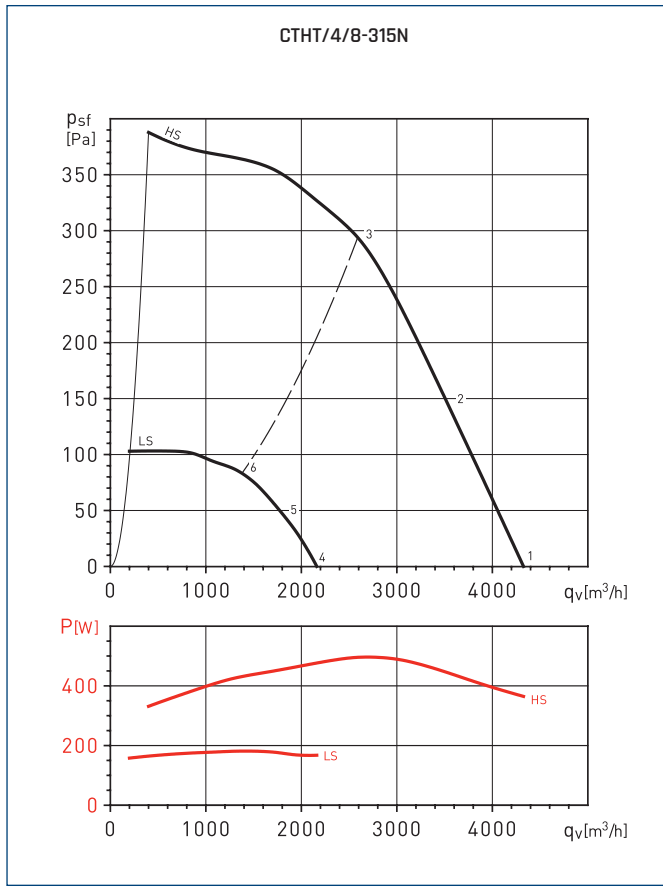

Poziom mocy akustycznej [dB(A)]

Punkt pracy		63	125	250	500	1000	2000	4000	8000	L _{WA}
1	Wlot	50	65	71	71	70	69	70	73	79
	Wylot	52	69	76	78	77	74	74	72	84
2	Wlot	50	63	71	70	68	67	67	69	77
	Wylot	51	69	75	77	75	72	70	69	82
3	Wlot	49	59	69	67	66	65	65	60	74
	Wylot	51	67	71	75	72	69	68	63	79
4	Wlot	36	51	57	57	56	55	56	59	65
	Wylot	38	55	62	64	62	60	60	58	69
5	Wlot	36	50	57	56	54	53	53	55	63
	Wylot	37	56	61	63	61	58	57	55	68
6	Wlot	36	45	55	53	52	51	52	47	60
	Wylot	37	53	58	62	58	56	55	50	66

Poziom mocy akustycznej [dB(A)]

Punkt pracy		63	125	250	500	1000	2000	4000	8000	L _{WA}
1	Wlot	44	65	75	72	84	76	67	75	86
	Wylot	47	74	76	86	89	85	73	78	93
2	Wlot	41	63	75	71	79	69	65	65	81
	Wylot	41	71	74	86	87	75	71	69	90
3	Wlot	45	62	77	68	67	69	68	63	79
	Wylot	43	70	72	83	78	72	72	68	85
4	Wlot	30	51	61	58	70	62	53	61	72
	Wylot	33	60	62	72	75	71	59	64	78
5	Wlot	27	49	61	57	65	55	51	51	68
	Wylot	27	57	60	72	73	61	57	55	76
6	Wlot	31	48	63	54	53	55	54	49	65
	Wylot	29	56	58	69	64	58	58	54	71

CHARAKTERYSTYKI PRACY

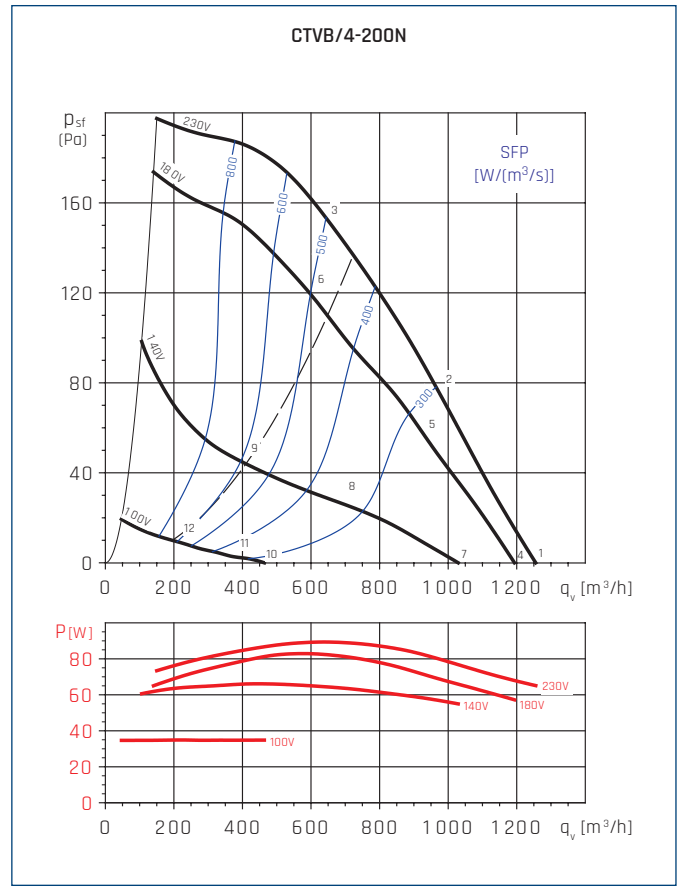
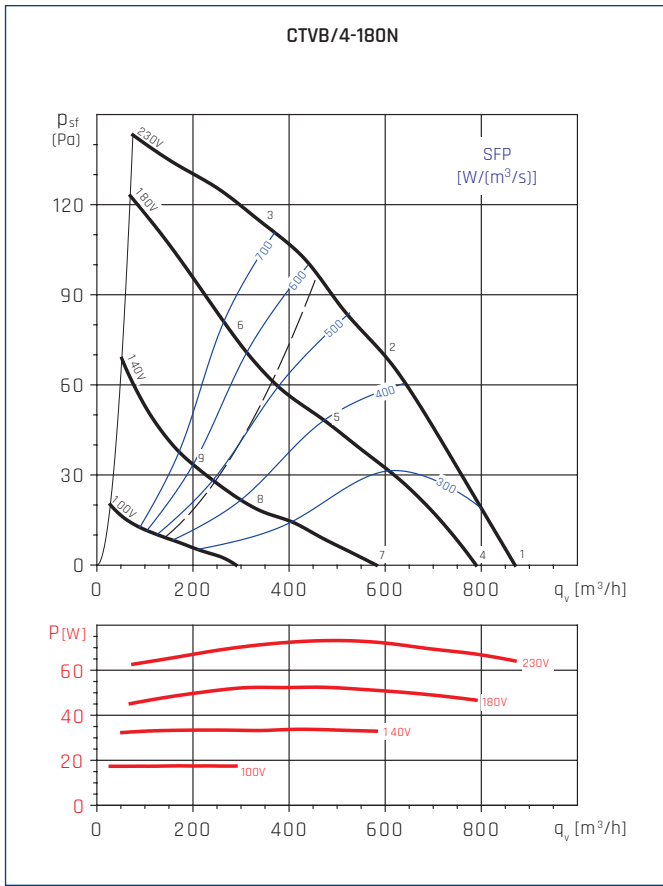

Poziom mocy akustycznej [dB(A)]

Punkt pracy		63	125	250	500	1000	2000	4000	8000	L _{WA}
1	Wlot	33	47	54	61	56	55	60	45	65
	Wylot	35	48	56	65	62	61	62	47	69
2	Wlot	34	47	53	60	55	54	53	44	63
	Wylot	34	45	55	62	61	60	54	46	66
3	Wlot	42	47	53	60	55	54	51	44	63
	Wylot	43	48	55	63	62	61	55	47	67
4	Wlot	31	45	52	59	54	52	58	43	63
	Wylot	33	46	54	63	60	59	60	45	67
5	Wlot	29	42	49	55	51	49	48	40	58
	Wylot	30	40	50	57	56	55	50	41	61
6	Wlot	38	43	48	56	51	50	47	40	59
	Wylot	39	43	51	59	57	57	51	42	63
7	Wlot	24	38	45	52	47	46	51	37	56
	Wylot	26	39	48	56	53	53	53	38	60
8	Wlot	20	34	40	46	42	40	39	31	49
	Wylot	21	31	41	48	47	46	41	32	53
9	Wlot	30	34	40	47	43	41	39	32	50
	Wylot	30	35	42	50	49	48	42	34	54

Poziom mocy akustycznej [dB(A)]

Punkt pracy		63	125	250	500	1000	2000	4000	8000	L _{WA}
1	Wlot	35	50	59	60	59	58	63	46	67
	Wylot	34	54	58	63	63	63	63	49	69
2	Wlot	38	52	59	60	58	57	55	45	65
	Wylot	36	53	57	63	63	62	57	49	68
3	Wlot	41	52	59	60	59	57	55	46	66
	Wylot	41	53	57	64	63	62	57	50	69
4	Wlot	34	49	58	59	58	57	62	45	66
	Wylot	33	53	57	63	62	62	62	48	69
5	Wlot	36	50	57	58	56	55	53	43	63
	Wylot	34	51	55	61	60	60	55	47	66
6	Wlot	39	50	57	58	57	55	53	44	64
	Wylot	39	51	55	62	61	60	55	48	67
7	Wlot	31	46	55	56	55	54	59	41	63
	Wylot	30	50	54	59	59	59	59	45	65
8	Wlot	27	40	48	48	46	45	43	34	54
	Wylot	25	41	45	51	51	50	45	37	56
9	Wlot	29	40	47	48	47	45	43	34	54
	Wylot	29	41	46	52	51	50	45	38	57
10	Wlot	13	28	37	38	37	36	41	24	45
	Wylot	12	32	36	42	41	41	41	27	48
11	Wlot	11	24	31	32	30	29	27	17	38
	Wylot	8	25	29	35	35	34	29	21	40
12	Wlot	13	24	31	32	31	29	27	18	38
	Wylot	13	25	30	36	35	34	29	22	41

CHARAKTERYSTYKI PRACY

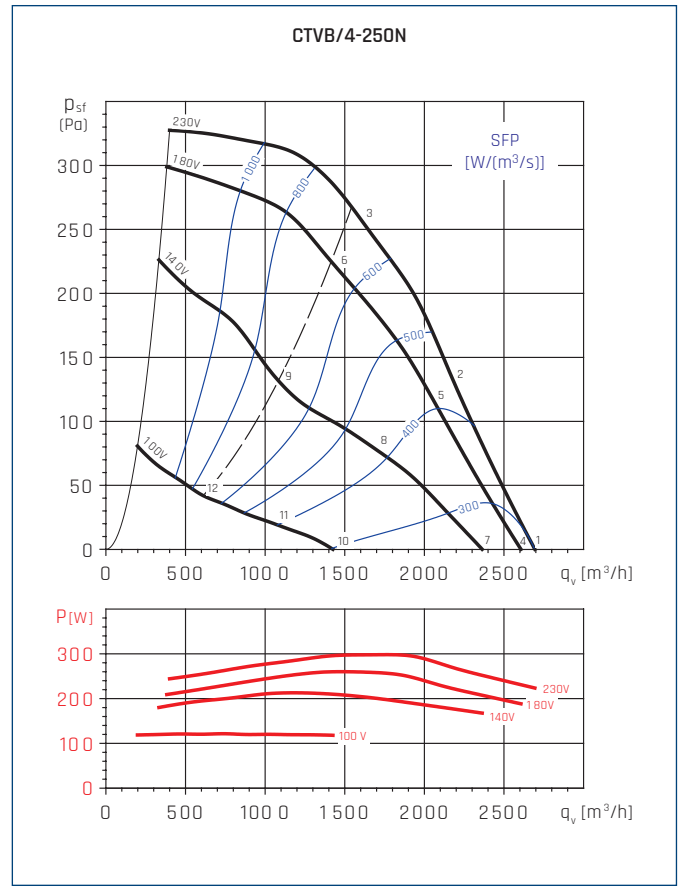
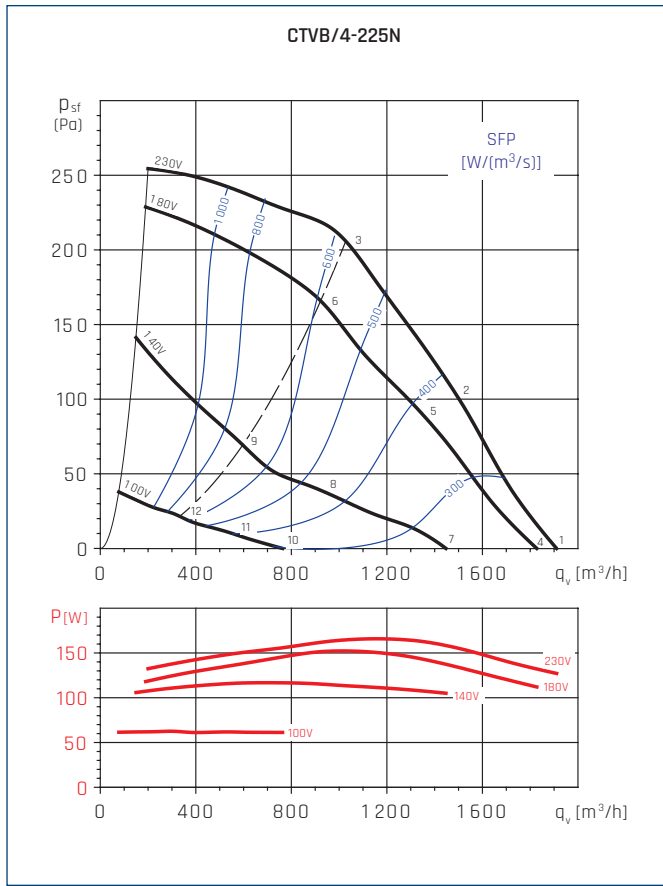

Poziom mocy akustycznej [dB(A)]

Punkt pracy		63	125	250	500	1000	2000	4000	8000	L _{WA}
1	Wlot	43	60	66	69	63	62	65	51	73
	Wylot	47	62	65	72	70	67	65	53	76
2	Wlot	43	57	64	68	61	59	58	46	71
	Wylot	43	59	63	71	69	65	59	49	74
3	Wlot	41	57	62	65	58	57	53	46	68
	Wylot	42	58	61	68	65	62	55	48	71
4	Wlot	42	59	65	68	62	61	64	50	72
	Wylot	46	61	64	71	69	66	64	52	75
5	Wlot	41	55	62	66	59	57	56	44	69
	Wylot	41	57	61	69	67	63	57	47	72
6	Wlot	39	55	60	63	56	55	51	44	66
	Wylot	40	56	59	66	63	60	53	46	69
7	Wlot	37	54	60	63	57	56	59	45	67
	Wylot	41	56	59	66	64	61	59	47	70
8	Wlot	32	46	53	57	50	48	47	35	60
	Wylot	32	48	52	60	58	54	48	38	64
9	Wlot	29	45	50	53	46	45	41	34	57
	Wylot	30	46	49	56	53	50	43	36	60
10	Wlot	23	40	46	49	43	42	45	31	53
	Wylot	27	42	45	52	50	47	45	33	56
11	Wlot	19	33	40	44	37	35	34	22	47
	Wylot	19	35	39	47	45	41	35	25	51
12	Wlot	16	32	37	40	33	32	28	21	44
	Wylot	17	33	36	43	40	37	30	23	47

Poziom mocy akustycznej [dB(A)]

Punkt pracy		63	125	250	500	1000	2000	4000	8000	L _{WA}
1	Wlot	46	62	67	69	63	66	66	59	74
	Wylot	47	65	70	70	70	70	67	58	77
2	Wlot	44	59	65	67	62	66	58	54	72
	Wylot	45	62	67	68	69	69	59	54	75
3	Wlot	43	57	63	66	63	62	56	52	71
	Wylot	45	61	66	67	69	66	60	53	74
4	Wlot	46	62	67	69	63	66	66	59	74
	Wylot	47	65	70	70	70	70	67	58	76
5	Wlot	43	58	64	66	61	65	57	53	71
	Wylot	44	61	66	67	68	68	58	53	74
6	Wlot	42	56	62	65	62	61	55	51	69
	Wylot	44	60	65	66	68	65	59	52	72
7	Wlot	43	59	64	66	60	63	63	56	71
	Wylot	44	62	67	67	67	67	64	55	74
8	Wlot	39	54	60	62	57	61	53	49	67
	Wylot	40	57	62	63	64	64	54	49	70
9	Wlot	36	50	56	59	56	55	49	45	63
	Wylot	38	54	59	60	62	59	53	46	67
10	Wlot	32	48	53	55	49	52	52	45	60
	Wylot	33	51	56	56	56	56	53	44	63
11	Wlot	26	41	47	49	44	48	40	36	54
	Wylot	27	44	49	50	51	51	41	36	57
12	Wlot	23	37	43	46	43	42	36	32	51
	Wylot	25	41	46	47	49	46	40	33	54

CHARAKTERYSTYKI PRACY

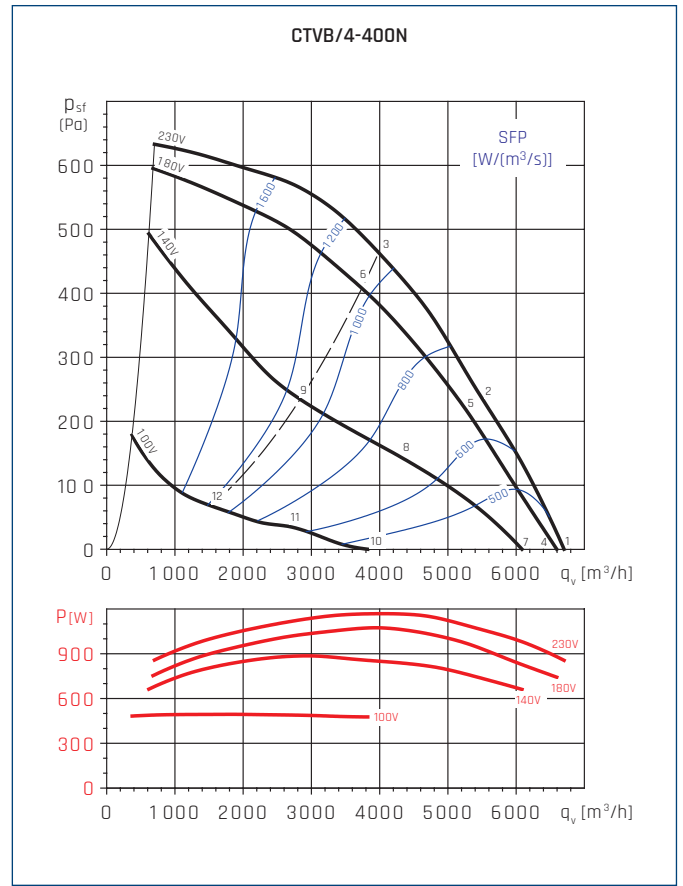
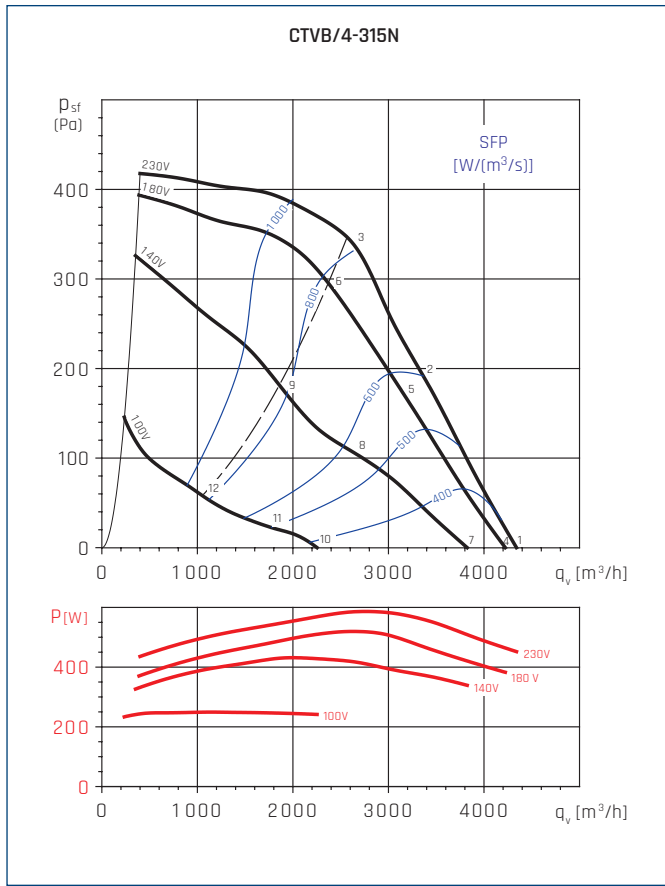

Poziom mocy akustycznej [dB(A)]

Punkt pracy		63	125	250	500	1000	2000	4000	8000	L_{WA}
1	Wlot	51	66	73	73	70	69	69	72	79
	Wylot	52	70	76	76	76	73	69	71	82
2	Wlot	49	64	70	70	68	67	63	64	76
	Wylot	50	66	73	74	74	70	64	64	80
3	Wlot	46	61	66	65	66	65	62	61	73
	Wylot	46	63	68	69	71	68	63	61	76
4	Wlot	50	66	72	72	69	69	68	71	79
	Wylot	51	69	75	75	75	72	68	70	82
5	Wlot	48	62	69	69	67	65	62	63	75
	Wylot	48	65	72	73	73	69	63	63	78
6	Wlot	45	59	64	64	65	64	61	59	71
	Wylot	45	62	67	68	69	67	62	60	75
7	Wlot	48	63	70	70	67	67	66	69	76
	Wylot	49	67	73	73	73	70	66	68	79
8	Wlot	43	58	65	65	62	61	57	58	70
	Wylot	44	60	67	68	68	65	58	58	74
9	Wlot	40	54	59	59	59	58	56	54	66
	Wylot	39	56	62	63	64	61	57	54	69
10	Wlot	37	52	59	59	56	55	55	58	65
	Wylot	38	56	62	62	62	59	55	57	68
11	Wlot	30	45	52	52	50	48	44	46	58
	Wylot	31	48	55	55	56	52	45	46	61
12	Wlot	27	42	47	46	47	46	44	42	54
	Wylot	27	44	50	50	52	49	44	42	57

Poziom mocy akustycznej [dB(A)]

Punkt pracy		63	125	250	500	1000	2000	4000	8000	L_{WA}
1	Wlot	49	65	73	75	85	76	70	77	87
	Wylot	59	73	75	78	88	81	71	76	90
2	Wlot	47	64	72	75	80	71	68	70	83
	Wylot	51	72	74	77	85	74	70	69	87
3	Wlot	44	61	71	71	70	70	69	66	78
	Wylot	46	69	71	73	75	72	69	66	80
4	Wlot	48	64	72	74	84	75	69	76	86
	Wylot	58	72	74	77	87	80	70	75	89
5	Wlot	46	63	71	74	79	70	67	69	81
	Wylot	50	71	73	76	84	73	69	68	85
6	Wlot	43	60	70	70	69	69	68	65	76
	Wylot	45	68	70	72	74	71	68	65	79
7	Wlot	47	63	71	73	83	74	68	75	85
	Wylot	57	71	73	76	86	79	69	74	87
8	Wlot	42	59	67	70	75	66	63	65	77
	Wylot	46	67	69	72	80	69	65	64	81
9	Wlot	37	54	64	64	63	63	62	59	70
	Wylot	39	62	64	66	68	65	62	59	73
10	Wlot	38	54	62	64	74	65	59	66	75
	Wylot	48	62	64	67	77	70	60	65	78
11	Wlot	29	46	54	57	62	53	50	52	64
	Wylot	33	54	56	59	67	56	52	51	68
12	Wlot	23	40	50	50	49	49	48	45	57
	Wylot	25	48	50	52	54	51	48	45	59

CHARAKTERYSTYKI PRACY

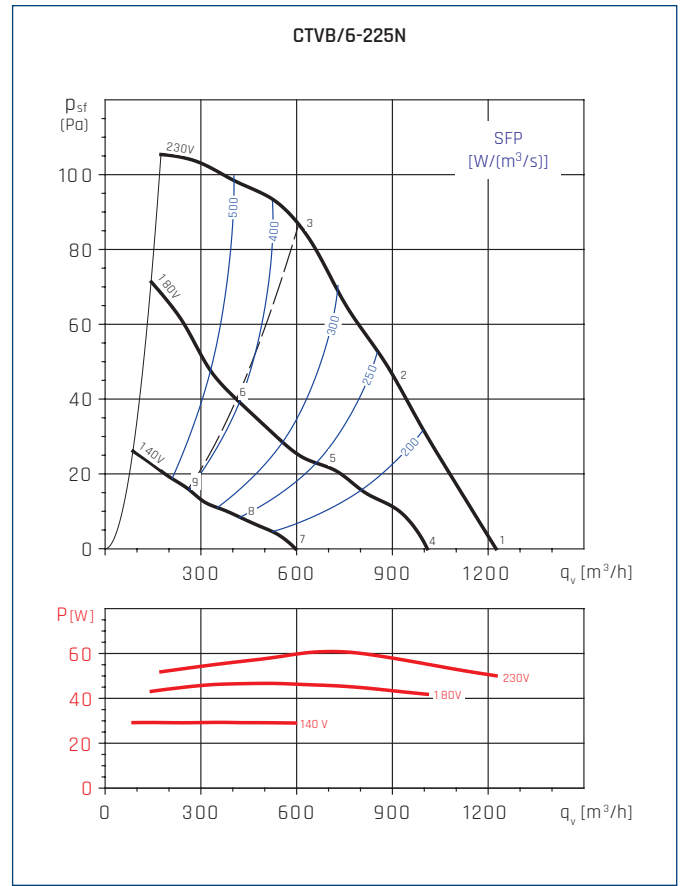
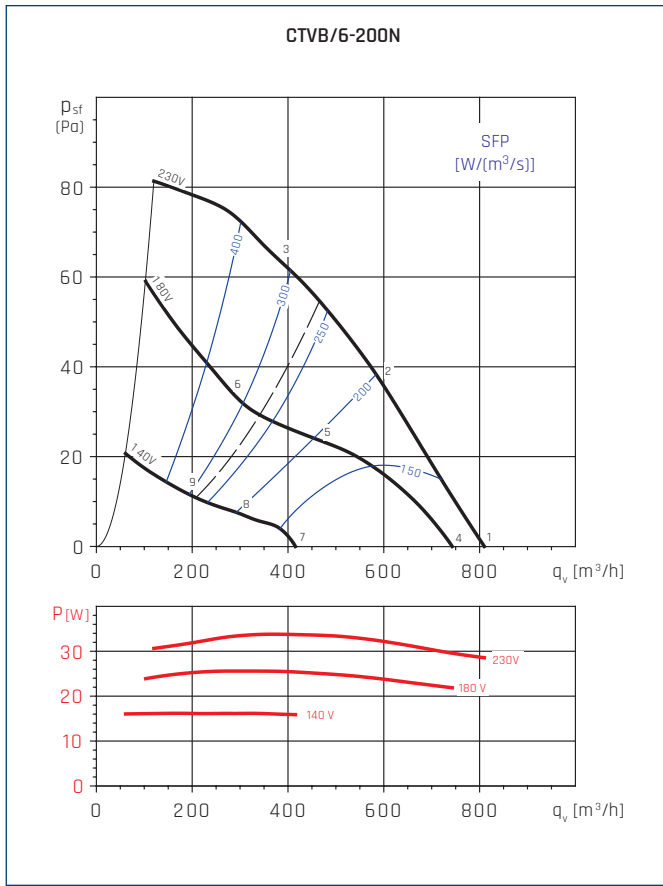

Poziom mocy akustycznej [dB(A)]

Punkt pracy		63	125	250	500	1000	2000	4000	8000	L_{WA}
1	Wlot	33	42	50	51	53	58	41	31	60
	Wylot	31	44	48	54	58	60	43	40	63
2	Wlot	33	41	49	50	53	50	41	36	57
	Wylot	32	43	48	53	59	53	42	35	61
3	Wlot	34	40	48	49	52	46	41	32	56
	Wylot	34	42	47	52	58	51	43	35	60
4	Wlot	31	40	48	49	52	56	39	30	59
	Wylot	30	42	46	52	57	58	42	39	61
5	Wlot	27	35	43	44	48	44	35	31	51
	Wylot	26	37	42	47	53	48	36	29	56
6	Wlot	28	33	42	43	46	40	35	26	50
	Wylot	27	36	41	46	52	45	37	29	54
7	Wlot	19	28	37	38	40	45	28	18	47
	Wylot	18	31	35	41	45	47	30	27	50
8	Wlot	16	24	32	33	37	33	24	19	40
	Wylot	15	26	31	36	42	36	25	18	44
9	Wlot	16	22	31	32	35	29	24	15	39
	Wylot	16	25	30	35	41	34	25	18	43

Poziom mocy akustycznej [dB(A)]

Punkt pracy		63	125	250	500	1000	2000	4000	8000	L_{WA}
1	Wlot	39	46	52	53	51	57	54	33	61
	Wylot	39	49	52	56	57	58	53	35	63
2	Wlot	40	44	50	51	48	51	46	30	57
	Wylot	41	46	48	54	55	53	46	33	60
3	Wlot	41	42	48	49	46	45	44	31	54
	Wylot	41	43	45	51	53	49	45	33	57
4	Wlot	35	43	49	50	47	53	51	29	58
	Wylot	36	45	48	53	54	54	50	32	60
5	Wlot	33	37	43	44	41	44	39	23	50
	Wylot	34	39	41	47	48	46	39	26	53
6	Wlot	33	33	40	41	38	37	36	23	46
	Wylot	33	35	37	43	44	41	37	25	49
7	Wlot	24	31	38	38	36	42	39	18	46
	Wylot	25	34	37	42	42	43	38	20	48
8	Wlot	22	27	33	33	31	34	28	13	40
	Wylot	24	29	31	37	38	35	28	16	42
9	Wlot	23	23	30	31	28	27	26	13	36
	Wylot	23	25	27	33	34	31	27	15	39
10	Wlot	12	19	25	26	24	30	27	6	34
	Wylot	12	22	25	29	30	31	26	8	36
11	Wlot	12	16	21	24	23	24	19	4	30
	Wylot	12	17	21	25	25	24	19	4	31
12	Wlot	12	16	21	24	23	24	19	4	30
	Wylot	12	16	21	24	23	24	19	4	30

CHARAKTERYSTYKI PRACY

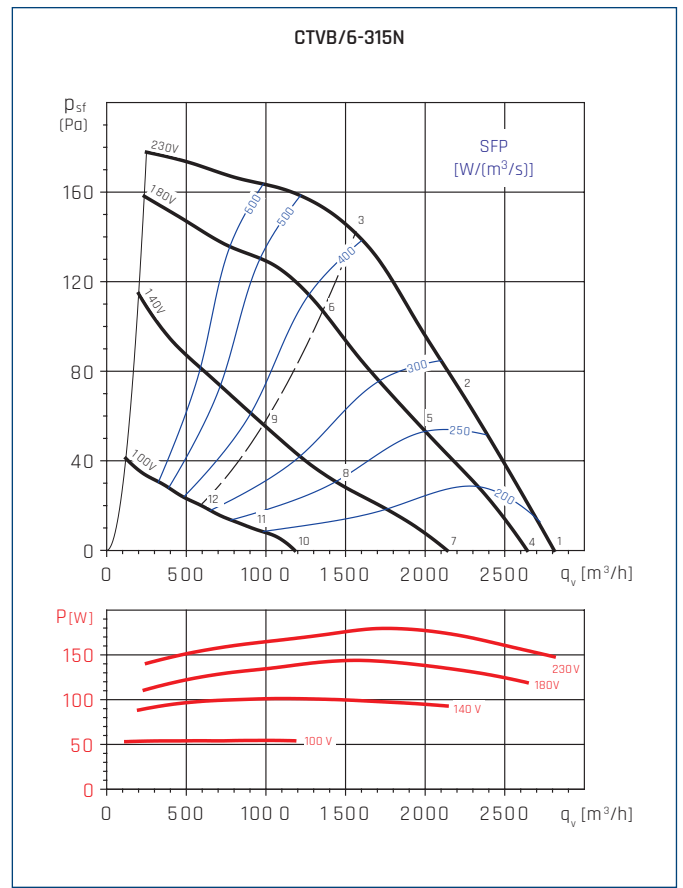
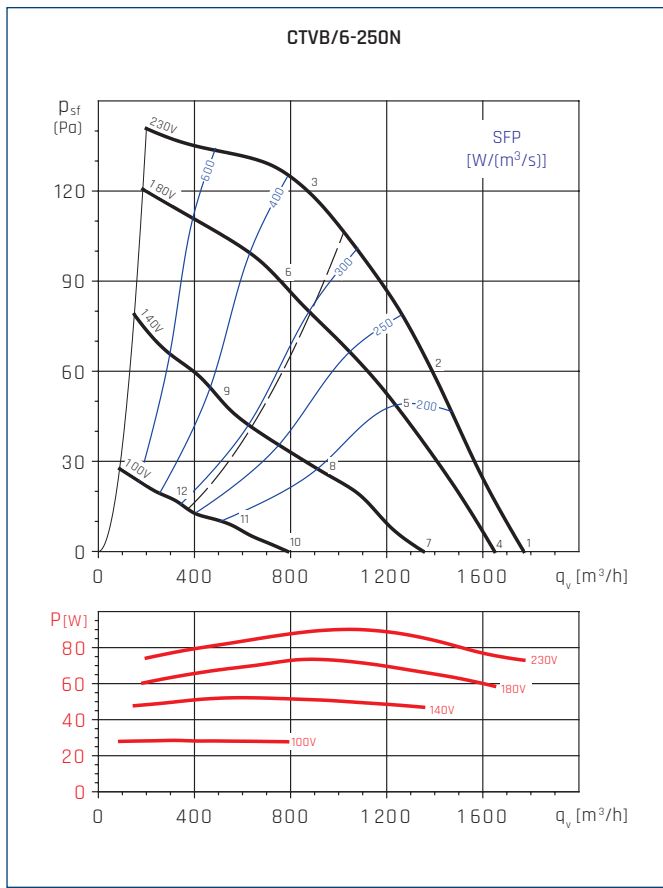

Poziom mocy akustycznej [dB(A)]

Punkt pracy		63	125	250	500	1000	2000	4000	8000	L_{WA}
1	Wlot	43	50	56	58	54	55	59	35	64
	Wylot	45	54	59	59	62	59	59	38	67
2	Wlot	44	48	54	56	53	51	53	34	61
	Wylot	47	52	57	57	60	54	53	36	64
3	Wlot	44	47	52	55	53	51	45	37	59
	Wylot	45	49	54	56	58	54	47	38	62
4	Wlot	41	48	54	56	52	53	57	33	62
	Wylot	43	52	57	57	60	57	57	36	65
5	Wlot	41	45	51	53	50	48	50	31	58
	Wylot	44	49	54	54	57	51	50	33	61
6	Wlot	40	43	48	51	49	47	41	33	56
	Wylot	41	45	50	52	54	50	43	34	59
7	Wlot	37	44	50	52	48	49	53	29	58
	Wylot	39	48	53	53	56	53	53	32	61
8	Wlot	35	39	45	47	44	42	44	25	52
	Wylot	38	43	48	48	51	45	44	27	55
9	Wlot	34	37	42	45	43	41	35	27	49
	Wylot	35	39	44	46	48	44	37	28	52
10	Wlot	25	32	38	40	36	37	41	17	46
	Wylot	27	36	41	41	44	41	41	20	49
11	Wlot	23	27	33	35	32	30	32	13	40
	Wylot	26	31	36	36	39	33	32	15	44
12	Wlot	22	25	30	33	31	29	23	15	38
	Wylot	23	27	32	34	36	32	25	16	41

Poziom mocy akustycznej [dB(A)]

Punkt pracy		63	125	250	500	1000	2000	4000	8000	L_{WA}
1	Wlot	46	55	62	61	59	61	64	44	69
	Wylot	48	58	64	64	64	64	63	45	71
2	Wlot	47	52	59	58	58	57	59	40	66
	Wylot	48	54	61	62	62	59	59	40	68
3	Wlot	46	48	53	55	56	56	57	40	63
	Wylot	47	50	56	58	60	57	57	41	65
4	Wlot	45	53	60	59	58	60	63	42	68
	Wylot	46	56	62	63	63	62	62	43	70
5	Wlot	44	50	56	56	55	54	57	37	63
	Wylot	45	52	58	59	60	56	56	38	65
6	Wlot	44	45	50	52	53	53	54	37	60
	Wylot	44	47	53	55	57	54	54	38	62
7	Wlot	40	49	56	55	53	55	58	38	63
	Wylot	42	52	58	58	58	58	57	39	65
8	Wlot	37	43	49	49	48	48	50	30	56
	Wylot	39	45	52	53	53	49	49	31	59
9	Wlot	37	39	43	45	46	46	48	30	53
	Wylot	37	40	46	48	50	47	47	31	55
10	Wlot	28	37	44	43	42	43	47	26	51
	Wylot	30	40	46	46	47	46	45	27	53
11	Wlot	27	32	39	38	38	37	39	20	46
	Wylot	28	35	41	42	43	39	39	21	48
12	Wlot	26	28	32	34	35	35	37	19	42
	Wylot	26	29	35	37	39	36	36	20	44

CHARAKTERYSTYKI PRACY

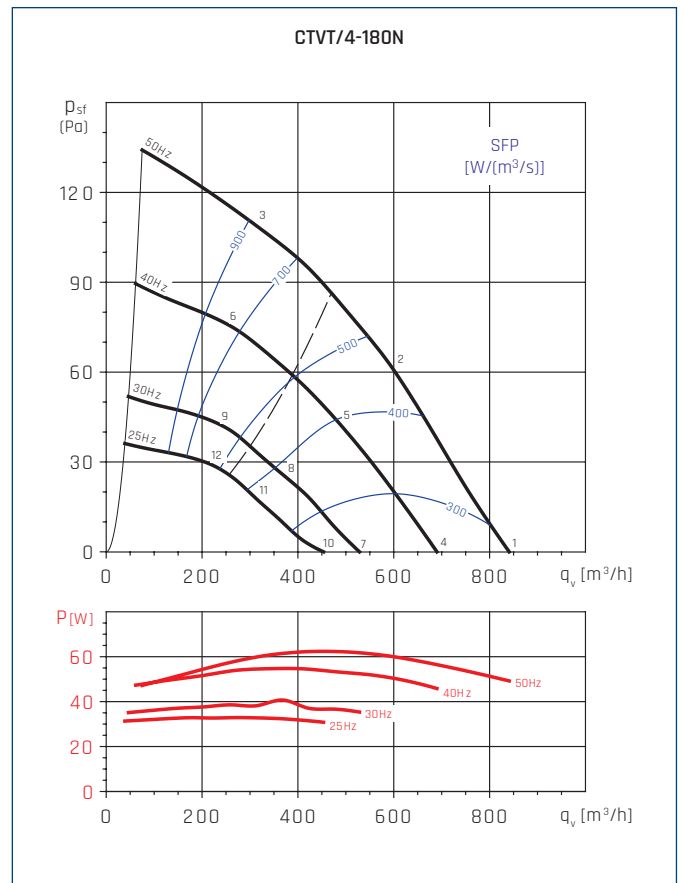
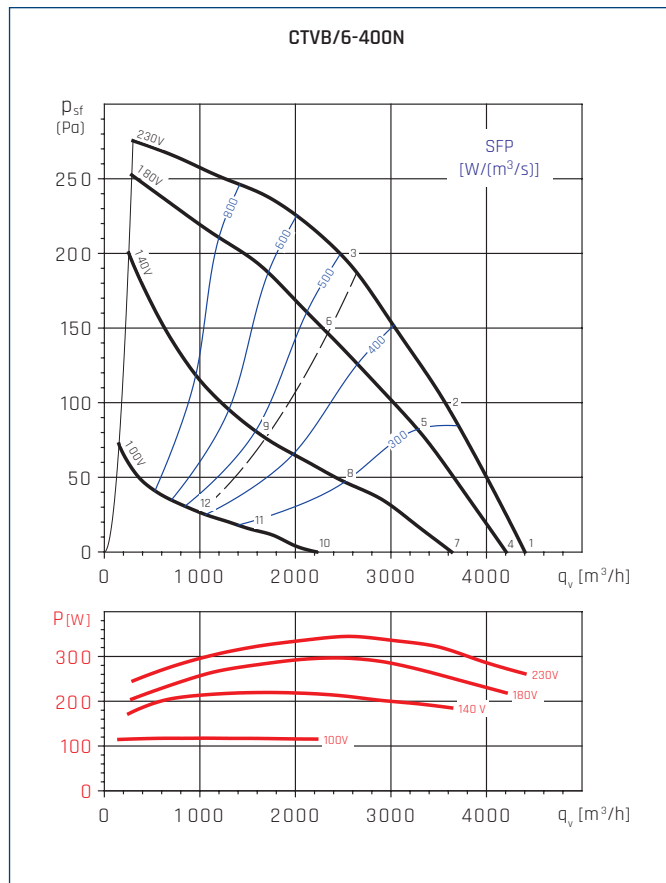

Poziom mocy akustycznej [dB(A)]

Punkt pracy		63	125	250	500	1000	2000	4000	8000	L_{WA}
1	Wlot	42	53	63	70	71	64	71	55	76
	Wylot	46	58	65	72	77	65	70	54	79
2	Wlot	45	53	61	68	66	63	67	53	73
	Wylot	47	56	63	71	71	64	66	53	75
3	Wlot	44	52	58	60	61	64	64	53	69
	Wylot	45	53	60	63	65	65	63	53	71
4	Wlot	41	52	62	69	70	63	70	54	75
	Wylot	45	57	64	71	76	64	69	53	78
5	Wlot	43	51	59	66	64	61	65	51	71
	Wylot	45	54	61	69	69	62	64	51	73
6	Wlot	41	49	55	57	58	61	61	50	67
	Wylot	42	50	57	60	62	62	60	50	68
7	Wlot	38	49	59	66	67	60	67	51	72
	Wylot	42	54	61	68	73	61	66	50	75
8	Wlot	38	46	54	61	59	56	60	46	65
	Wylot	40	49	56	64	64	57	59	46	68
9	Wlot	34	42	48	50	51	54	54	43	59
	Wylot	35	43	50	53	55	55	53	43	61
10	Wlot	27	38	48	55	56	49	56	40	61
	Wylot	31	43	50	57	62	50	55	39	64
11	Wlot	26	34	42	49	47	44	48	34	54
	Wylot	28	37	44	52	52	45	47	34	56
12	Wlot	23	31	37	39	40	43	43	32	48
	Wylot	24	32	39	42	44	44	42	32	50

Poziom mocy akustycznej [dB(A)]

Punkt pracy		63	125	250	500	1000	2000	4000	8000	L_{WA}
1	Wlot	32	46	53	60	55	54	59	45	64
	Wylot	34	47	56	64	61	61	61	46	68
2	Wlot	33	46	53	59	54	53	52	43	62
	Wylot	34	44	54	61	60	59	53	45	65
3	Wlot	42	46	52	59	55	53	51	44	62
	Wylot	42	47	54	62	61	60	54	46	66
4	Wlot	28	42	49	55	50	49	54	40	60
	Wylot	30	43	51	60	57	56	57	42	64
5	Wlot	29	42	49	55	50	49	48	39	58
	Wylot	29	40	50	57	56	55	49	41	61
6	Wlot	38	42	48	55	50	49	47	40	58
	Wylot	38	43	50	58	57	56	50	42	62
7	Wlot	22	36	43	50	45	43	49	34	54
	Wylot	24	37	45	54	51	50	51	36	58
8	Wlot	23	37	43	49	45	43	42	34	52
	Wylot	24	34	44	51	50	49	44	35	56
9	Wlot	32	36	42	49	45	43	41	34	52
	Wylot	32	37	45	52	51	50	44	36	57
10	Wlot	18	32	39	46	41	40	45	31	50
	Wylot	20	33	42	50	47	47	47	32	54
11	Wlot	20	33	39	45	41	39	39	30	49
	Wylot	20	31	41	47	46	45	40	32	52
12	Wlot	28	33	38	46	41	40	37	30	49
	Wylot	29	33	41	49	47	47	41	32	53

CHARAKTERYSTYKI PRACY

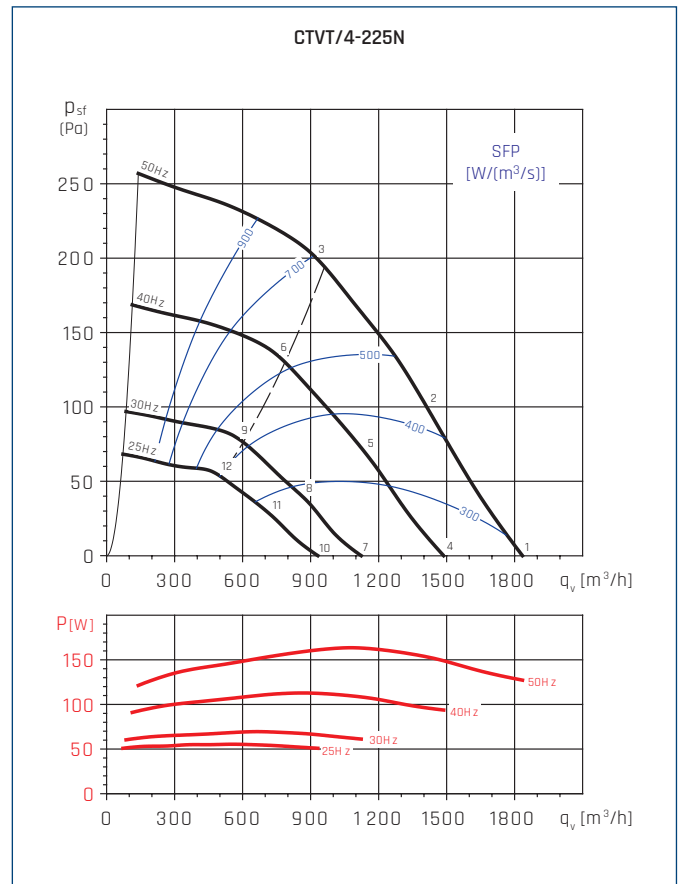
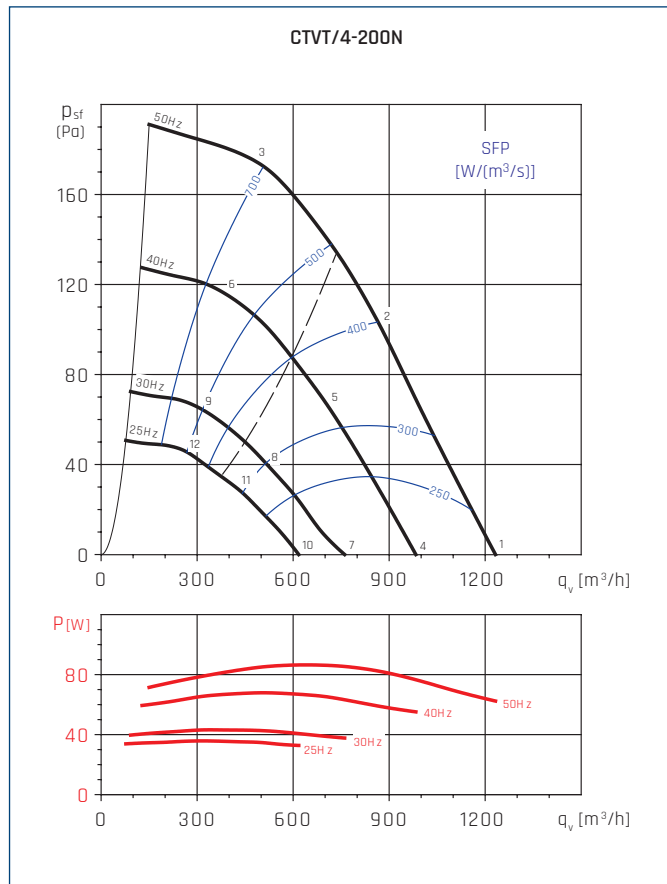

Poziom mocy akustycznej [dB(A)]

Punkt pracy		63	125	250	500	1000	2000	4000	8000	L _{WA}
1	Wlot	35	49	58	60	59	58	62	45	67
	Wylot	34	54	58	63	63	63	62	49	69
2	Wlot	38	51	59	60	58	57	55	45	65
	Wylot	36	53	57	63	62	62	57	48	68
3	Wlot	40	51	59	60	59	57	55	46	65
	Wylot	40	53	57	63	63	62	57	49	68
4	Wlot	30	45	54	55	54	53	58	41	62
	Wylot	29	49	53	59	58	58	58	44	65
5	Wlot	34	47	55	55	53	52	50	41	61
	Wylot	32	48	52	58	58	57	52	44	63
6	Wlot	36	47	55	55	54	52	51	41	61
	Wylot	36	48	53	59	58	57	52	45	64
7	Wlot	24	39	48	49	48	47	52	35	56
	Wylot	23	43	47	53	52	52	52	38	59
8	Wlot	28	41	49	49	47	46	45	35	55
	Wylot	26	43	47	52	52	51	46	38	58
9	Wlot	30	41	49	49	49	47	45	35	55
	Wylot	30	42	47	53	52	51	46	39	58
10	Wlot	20	35	44	45	44	43	48	31	52
	Wylot	19	39	43	49	48	48	48	34	55
11	Wlot	24	37	45	45	44	43	41	31	51
	Wylot	22	39	43	49	48	48	43	34	54
12	Wlot	26	37	45	46	45	43	41	32	51
	Wylot	26	39	43	49	49	48	43	35	54

Poziom mocy akustycznej [dB(A)]

Punkt pracy		63	125	250	500	1000	2000	4000	8000	L _{WA}
1	Wlot	43	60	66	69	63	62	65	51	73
	Wylot	47	62	65	72	70	67	65	53	76
2	Wlot	43	57	64	68	61	59	58	46	71
	Wylot	43	59	63	71	69	65	59	49	74
3	Wlot	41	57	62	65	58	57	53	46	68
	Wylot	42	58	61	68	65	62	55	48	71
4	Wlot	38	55	61	64	58	57	60	46	68
	Wylot	42	57	60	67	65	62	60	48	71
5	Wlot	38	52	59	63	56	54	53	41	66
	Wylot	38	54	58	66	64	60	54	44	70
6	Wlot	36	52	57	60	53	52	48	41	64
	Wylot	37	53	56	63	60	57	50	43	67
7	Wlot	32	49	55	58	52	51	54	40	62
	Wylot	36	51	54	61	59	56	54	42	65
8	Wlot	32	46	53	57	50	48	47	35	60
	Wylot	32	48	52	60	58	54	48	38	64
9	Wlot	30	46	51	54	47	46	42	35	58
	Wylot	31	47	50	57	54	51	44	37	61
10	Wlot	28	45	51	54	48	47	50	36	58
	Wylot	32	47	50	57	55	52	50	38	61
11	Wlot	29	43	50	54	47	45	44	32	56
	Wylot	29	45	49	57	55	51	45	35	60
12	Wlot	27	43	48	51	44	43	39	32	54
	Wylot	28	44	47	54	51	48	41	34	57

CHARAKTERYSTYKI PRACY

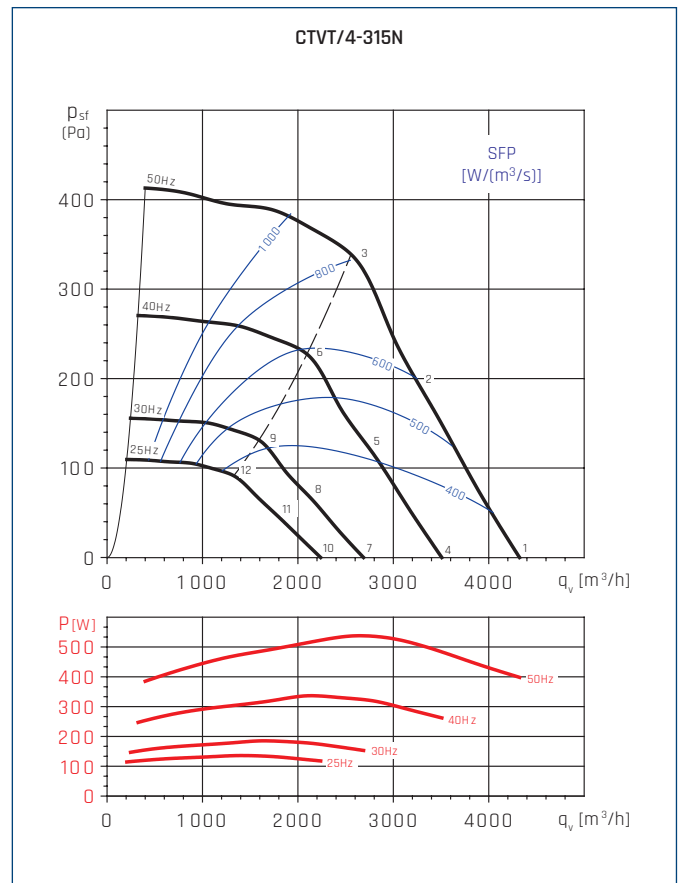
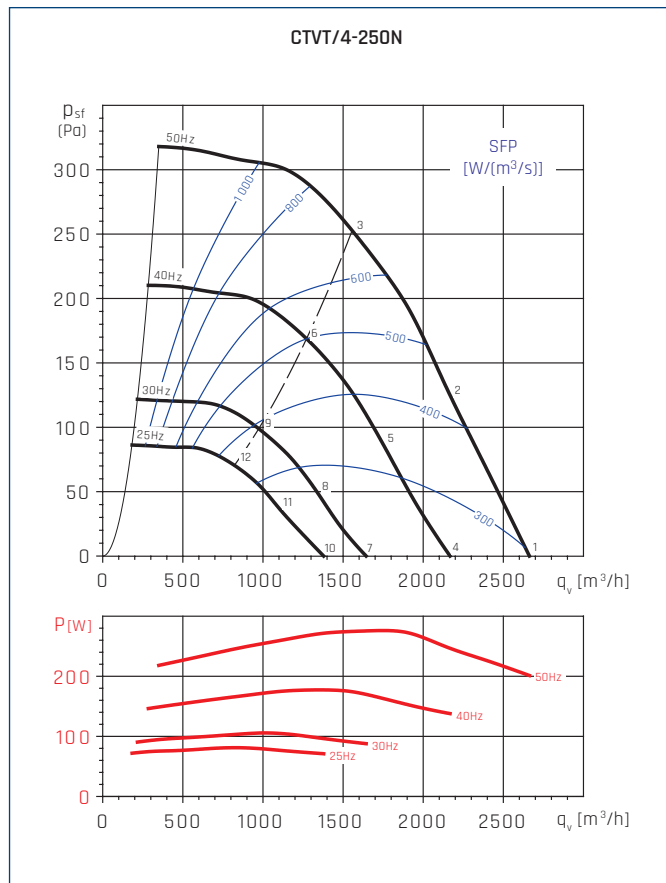

Poziom mocy akustycznej [dB(A)]

Punkt pracy		63	125	250	500	1000	2000	4000	8000	L_{WA}
1	Wlot	46	62	67	69	63	66	66	59	74
	Wylot	47	65	70	70	70	70	67	58	77
2	Wlot	44	59	65	67	62	66	58	54	72
	Wylot	45	62	67	68	69	69	59	54	75
3	Wlot	43	57	63	66	63	62	56	52	70
	Wylot	45	61	66	67	69	66	60	53	74
4	Wlot	41	57	62	64	58	61	61	54	69
	Wylot	42	60	65	65	65	65	62	53	72
5	Wlot	40	55	61	63	58	62	54	50	67
	Wylot	41	58	63	64	65	65	55	50	70
6	Wlot	39	53	59	62	59	58	52	48	66
	Wylot	41	57	62	63	65	62	56	49	69
7	Wlot	35	51	56	58	52	55	55	48	64
	Wylot	36	54	59	59	59	59	56	47	66
8	Wlot	34	49	55	57	52	56	48	44	62
	Wylot	35	52	57	58	59	59	49	44	65
9	Wlot	33	47	53	56	53	52	46	42	60
	Wylot	35	51	56	57	59	56	50	43	64
10	Wlot	32	48	53	55	49	52	52	45	60
	Wylot	33	51	56	56	56	56	53	44	63
11	Wlot	30	45	51	53	48	52	44	40	58
	Wylot	31	48	53	54	55	55	45	40	61
12	Wlot	29	43	49	52	49	48	42	38	56
	Wylot	31	47	52	53	55	52	46	39	60

Poziom mocy akustycznej [dB(A)]

Punkt pracy		63	125	250	500	1000	2000	4000	8000	L_{WA}
1	Wlot	51	66	73	72	70	69	69	72	79
	Wylot	52	70	76	76	76	73	69	71	82
2	Wlot	49	63	70	70	68	66	63	64	76
	Wylot	50	66	73	74	74	70	64	64	80
3	Wlot	46	60	66	65	66	65	62	61	73
	Wylot	46	63	68	69	71	68	63	61	76
4	Wlot	46	62	68	68	65	65	64	67	75
	Wylot	47	65	71	71	71	68	64	66	78
5	Wlot	44	59	66	66	64	62	58	60	71
	Wylot	45	62	69	69	70	66	59	60	75
6	Wlot	42	56	61	61	62	61	58	56	68
	Wylot	42	59	64	65	66	64	59	56	71
7	Wlot	40	56	62	62	59	59	58	61	68
	Wylot	41	59	65	65	65	62	58	60	72
8	Wlot	39	53	60	60	58	56	52	54	66
	Wylot	39	56	63	64	64	60	54	54	69
9	Wlot	36	50	55	55	56	55	52	51	62
	Wylot	36	53	58	59	60	58	53	51	66
10	Wlot	36	52	58	58	55	55	54	57	65
	Wylot	38	55	61	61	62	58	54	57	68
11	Wlot	35	49	56	56	54	52	49	50	62
	Wylot	35	52	59	60	60	56	50	50	65
12	Wlot	32	46	52	51	52	51	48	47	59
	Wylot	32	49	54	55	57	54	49	47	62

CHARAKTERYSTYKI PRACY

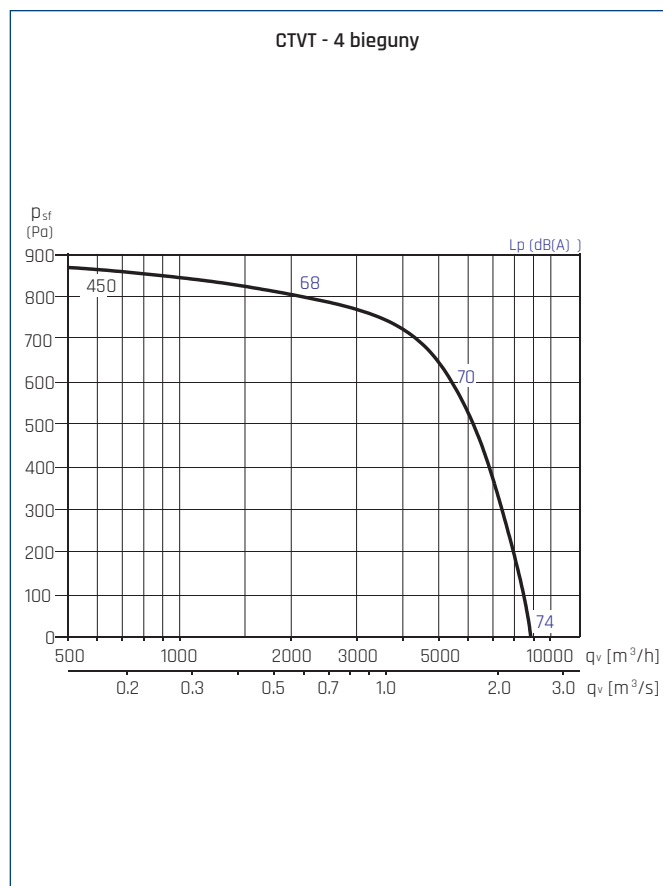
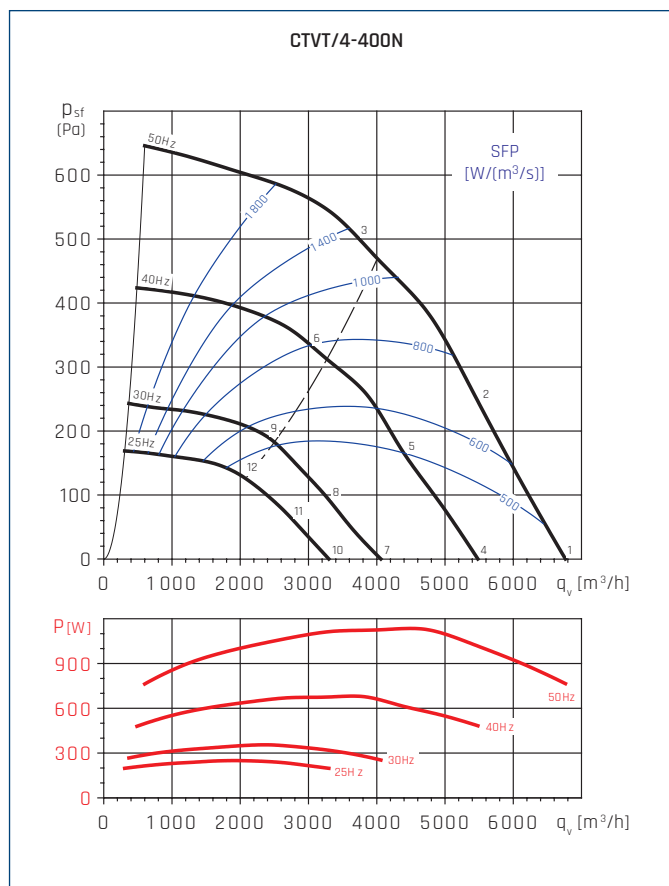

Poziom mocy akustycznej [dB(A)]

Punkt pracy		63	125	250	500	1000	2000	4000	8000	L_{WA}
1	Wlot	44	63	72	72	85	76	71	76	86
	Wylot	59	72	75	77	88	82	75	76	90
2	Wlot	43	61	73	71	80	71	67	68	82
	Wylot	51	71	73	76	85	74	70	68	86
3	Wlot	44	62	71	68	69	70	68	64	77
	Wylot	48	68	71	73	74	72	70	65	80
4	Wlot	39	58	67	67	80	71	66	71	82
	Wylot	54	67	70	72	83	77	70	71	85
5	Wlot	39	57	69	67	76	67	63	64	78
	Wylot	47	67	69	72	81	70	66	64	82
6	Wlot	40	58	67	64	65	66	64	60	72
	Wylot	44	64	67	69	70	68	66	61	75
7	Wlot	33	52	61	61	74	65	60	65	76
	Wylot	48	61	64	66	77	71	64	65	79
8	Wlot	33	51	63	61	70	61	57	58	72
	Wylot	41	61	63	66	75	64	60	58	76
9	Wlot	34	52	61	58	59	60	58	54	66
	Wylot	38	58	61	63	64	62	60	55	69
10	Wlot	29	48	57	57	70	61	56	61	72
	Wylot	44	57	60	62	73	67	60	61	75
11	Wlot	29	47	59	57	66	57	53	54	68
	Wylot	37	57	59	62	71	60	56	54	72
12	Wlot	30	48	57	54	55	56	54	50	63
	Wylot	34	54	57	59	60	58	56	51	65

CHARAKTERYSTYKI PRACY

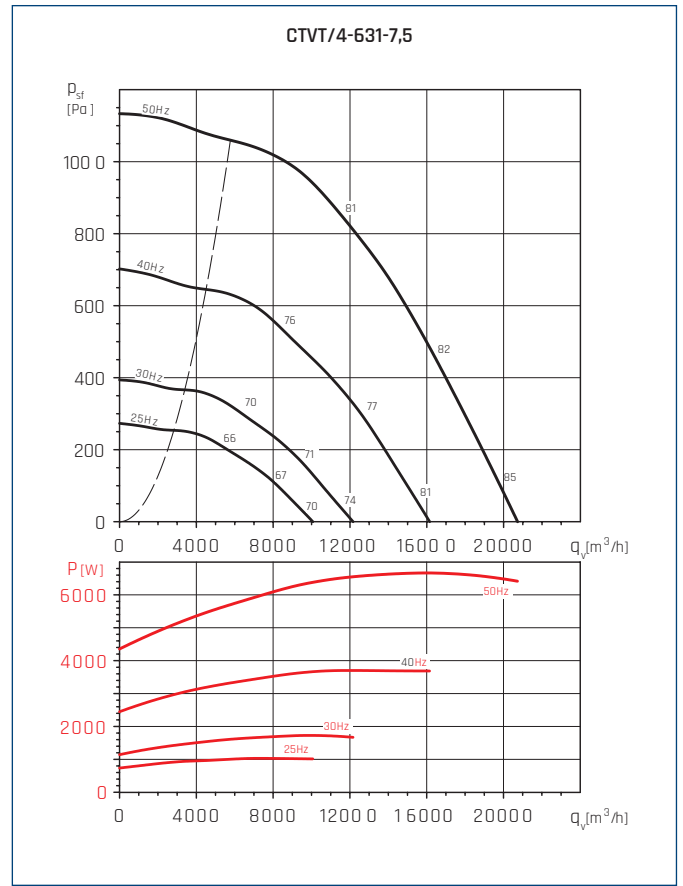
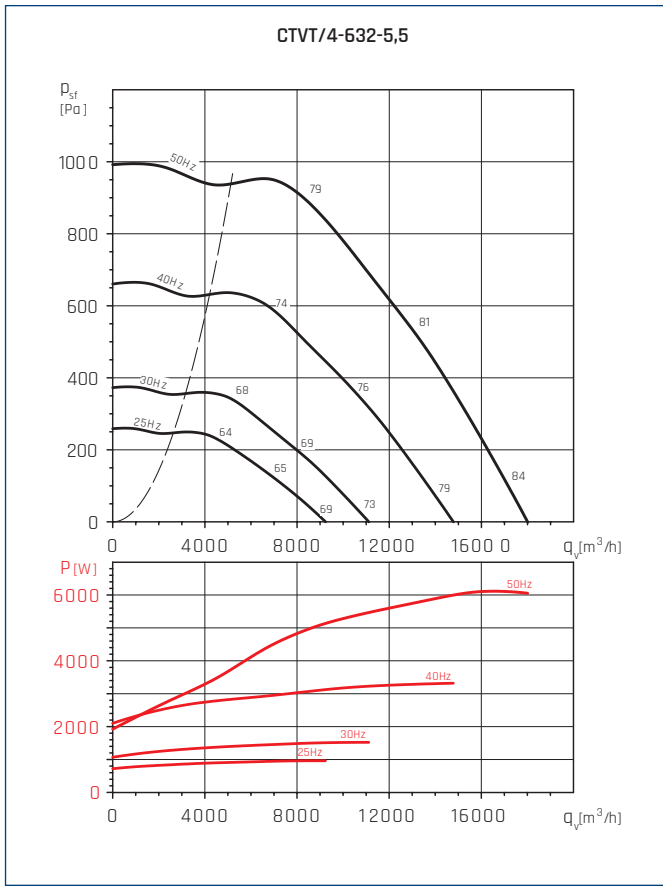

Poziom mocy akustycznej [dB(A)]

Regulacja	63	125	250	500	1000	2000	4000	8000	STD*	INS*	
50Hz	LP	74	82	96	93	93	97	90	80	101	96
	MP	70	81	95	90	91	90	84	76	98	92
	HP	70	80	93	89	90	87	81	75	97	89
40Hz	LP	69	77	91	88	88	92	85	75	96	91
	MP	65	76	90	85	86	85	79	71	93	87
	HP	65	75	89	84	85	83	76	70	92	84
30Hz	LP	63	71	84	82	82	86	79	69	90	84
	MP	59	70	84	79	79	79	72	65	87	81
	HP	59	69	82	78	79	76	70	64	86	78
25Hz	LP	59	67	80	78	78	82	75	65	86	80
	MP	55	66	80	75	76	75	69	61	83	77
	HP	55	65	78	74	75	72	66	60	82	74

* STD - Wersja standardowa

* INS - Wersja akustyczna

Poziom mocy akustycznej [dB(A)]

Regulacja	63	125	250	500	1000	2000	4000	8000	STD*	INS*	
50Hz	LP	75	84	97	95	95	98	92	82	103	97
	MP	72	83	95	92	93	92	85	77	99	94
	HP	72	82	95	91	92	89	83	77	99	92
40Hz	LP	71	79	92	90	90	93	87	77	98	92
	MP	67	78	91	87	88	87	81	73	95	89
	HP	67	77	90	86	87	84	79	72	94	87
30Hz	LP	64	73	86	84	84	87	81	71	92	86
	MP	61	72	84	81	81	80	74	66	88	83
	HP	61	71	84	80	81	78	72	66	87	80
25Hz	LP	60	69	82	80	80	83	77	67	88	82
	MP	57	68	80	77	78	76	70	62	84	79
	HP	57	67	80	76	77	74	68	62	84	77

* STD - Wersja standardowa

* INS - Wersja akustyczna

CHARAKTERYSTYKI PRACY

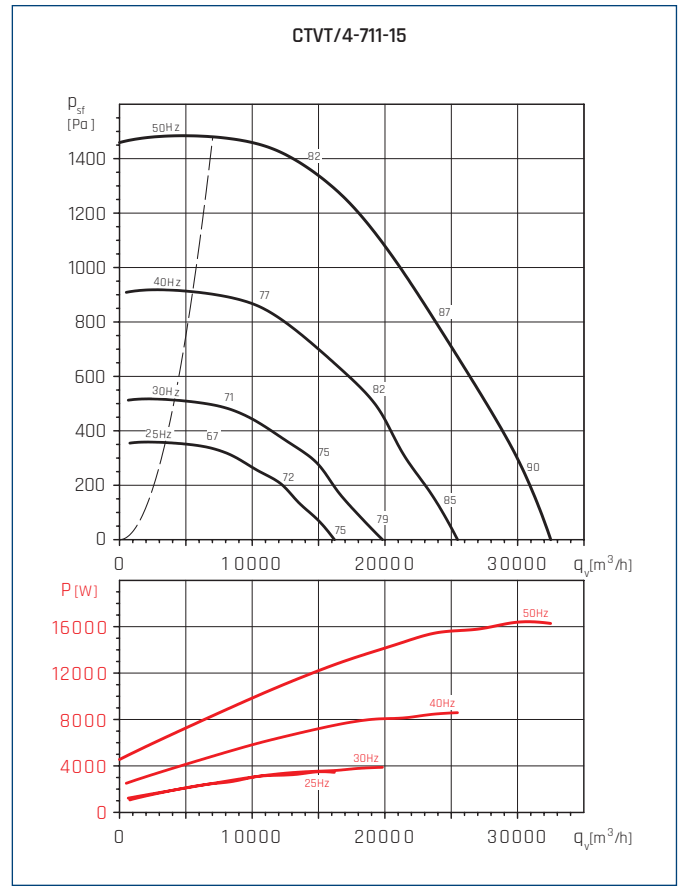
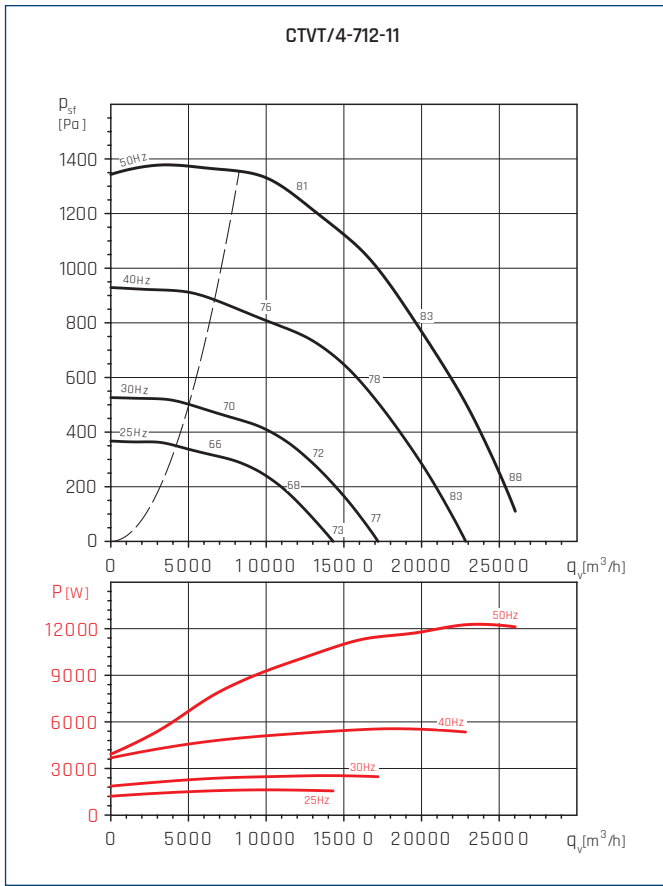

Poziom mocy akustycznej [dB(A)]

Regulacja	63	125	250	500	1000	2000	4000	8000	STD*	INS*	
50Hz	LP	78	87	97	98	99	100	95	86	105	99
	MP	73	85	94	95	95	93	88	79	101	95
	HP	72	84	93	92	93	89	84	77	98	91
40Hz	LP	73	82	92	93	94	95	91	81	101	94
	MP	68	80	90	90	90	88	83	74	96	91
	HP	67	80	88	88	88	84	79	72	94	87
30Hz	LP	66	76	86	87	88	89	84	74	94	88
	MP	62	74	83	84	84	82	77	68	90	84
	HP	61	73	82	81	81	78	73	66	87	80
25Hz	LP	62	72	82	83	84	85	80	70	90	84
	MP	58	70	79	80	80	78	73	64	86	80
	HP	57	69	78	77	77	74	69	62	83	76

* STD - Wersja standardowa

* INS - Wersja akustyczna

Poziom mocy akustycznej [dB(A)]

Regulacja	63	125	250	500	1000	2000	4000	8000	STD*	INS*	
50Hz	LP	79	90	98	101	102	102	98	88	107	101
	MP	76	89	95	99	99	96	91	82	104	100
	HP	73	87	93	94	94	90	86	77	100	93
40Hz	LP	74	85	93	96	97	97	93	83	103	96
	MP	72	84	91	94	94	91	86	77	99	95
	HP	69	82	88	90	89	85	81	73	95	88
30Hz	LP	68	79	87	90	91	90	87	77	96	90
	MP	65	77	84	88	88	85	80	71	93	89
	HP	62	76	81	83	83	79	74	66	88	82
25Hz	LP	64	75	83	86	87	86	83	73	92	86
	MP	61	74	80	84	84	81	76	67	89	85
	HP	58	72	77	79	79	75	71	62	84	78

* STD - Wersja standardowa

* INS - Wersja akustyczna

CHARAKTERYSTYKI PRACY

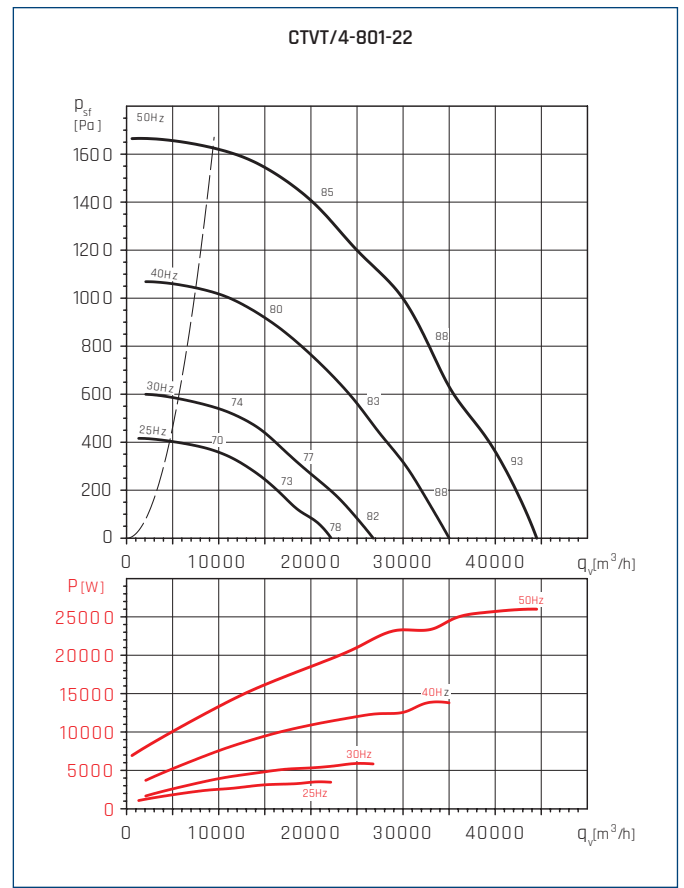
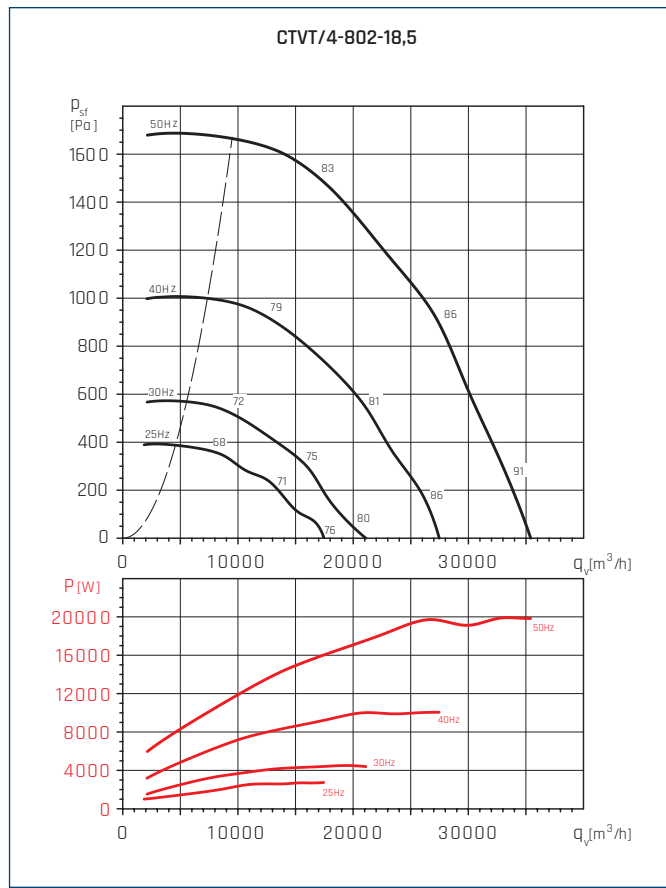

Poziom mocy akustycznej [dB(A)]

Regulacja	63	125	250	500	1000	2000	4000	8000	STD*	INS*
50Hz	LP	80	91	98	102	103	102	99	89	102
	MP	76	88	94	99	99	95	91	82	99
	HP	75	89	93	96	95	91	87	79	96
40Hz	LP	75	86	93	97	98	98	94	85	97
	MP	71	84	89	94	94	91	86	77	94
	HP	70	84	88	91	90	87	82	74	96
30Hz	LP	69	80	87	91	92	91	88	78	91
	MP	65	77	83	88	88	84	80	70	88
	HP	64	78	82	85	84	80	76	68	90
25Hz	LP	65	76	83	87	88	87	84	74	87
	MP	61	73	79	84	84	80	76	66	84
	HP	60	74	78	81	80	76	72	64	86

* STD - Wersja standardowa

* INS - Wersja akustyczna

Poziom mocy akustycznej [dB(A)]

Regulacja	63	125	250	500	1000	2000	4000	8000	STD*	INS*
50Hz	LP	82	94	99	105	106	104	102	92	104
	MP	78	90	95	101	101	97	93	83	106
	HP	76	91	94	98	97	93	89	80	102
40Hz	LP	77	89	95	100	101	99	97	87	99
	MP	73	85	90	96	96	92	88	78	101
	HP	72	86	89	93	92	88	84	75	98
30Hz	LP	71	82	88	94	95	93	91	81	93
	MP	66	79	83	90	90	86	82	72	94
	HP	65	80	83	87	86	82	78	69	91
25Hz	LP	67	79	84	90	91	89	87	77	89
	MP	63	75	80	86	86	82	78	68	90
	HP	61	76	79	83	82	78	74	65	87

* STD - Wersja standardowa

* INS - Wersja akustyczna

CHARAKTERYSTYKI PRACY

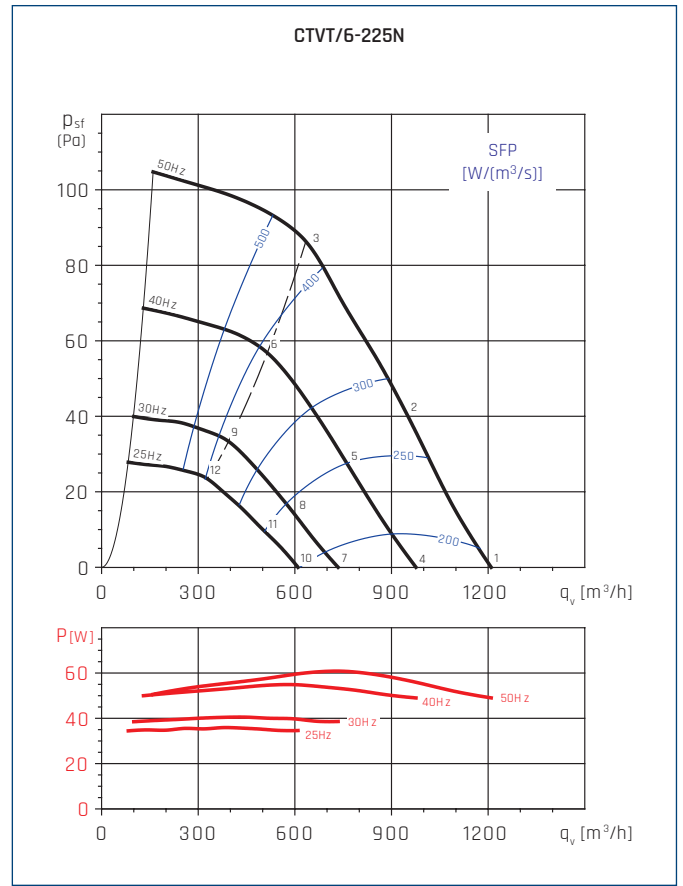
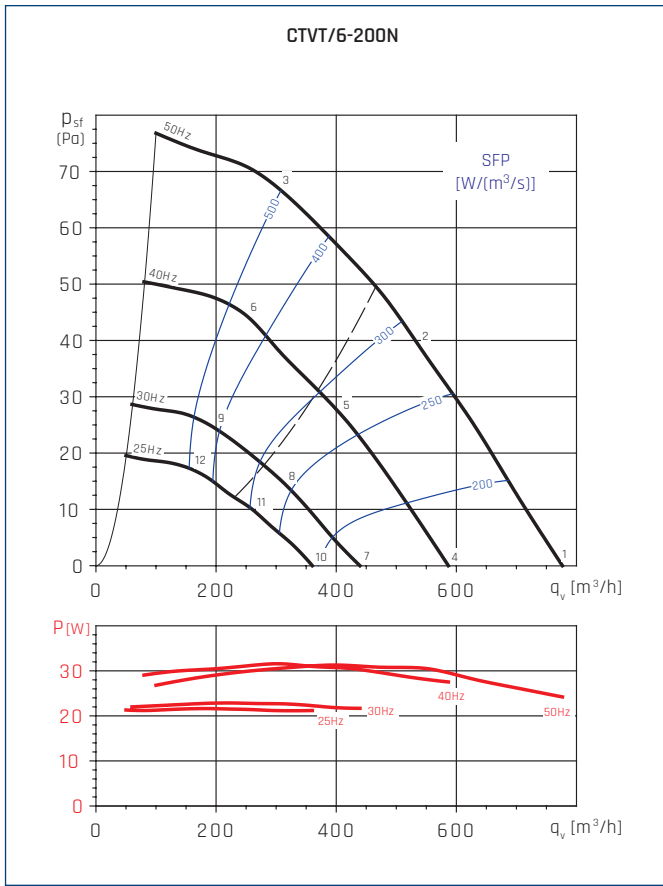

Poziom mocy akustycznej [dB(A)]

Punkt pracy		63	125	250	500	1000	2000	4000	8000	L_{WA}
1	Wlot	32	41	49	50	53	57	40	31	60
	Wylot	31	43	47	53	58	59	43	40	62
2	Wlot	32	41	48	49	53	49	40	36	57
	Wylot	32	43	48	52	59	53	41	34	61
3	Wlot	33	39	48	49	52	46	41	31	55
	Wylot	33	42	47	52	57	51	42	35	60
4	Wlot	28	37	45	46	48	53	36	26	55
	Wylot	26	39	43	49	53	55	38	35	58
5	Wlot	28	36	44	45	49	45	36	31	52
	Wylot	27	38	43	48	54	48	37	30	56
6	Wlot	29	35	43	44	47	41	36	27	51
	Wylot	29	37	42	47	53	46	38	30	55
7	Wlot	21	30	39	40	42	47	30	20	49
	Wylot	20	33	37	43	47	49	32	29	52
8	Wlot	22	30	38	39	42	39	30	25	46
	Wylot	21	32	37	42	48	42	31	24	50
9	Wlot	23	29	37	38	41	35	30	21	45
	Wylot	23	31	36	41	47	40	32	24	49
10	Wlot	17	26	34	35	38	42	25	16	45
	Wylot	16	29	32	38	43	44	28	25	48
11	Wlot	18	26	34	34	38	35	26	21	42
	Wylot	17	28	33	38	44	38	27	20	46
12	Wlot	19	25	33	34	37	31	26	17	41
	Wylot	19	27	32	37	43	36	28	20	45

Poziom mocy akustycznej [dB(A)]

Punkt pracy		63	125	250	500	1000	2000	4000	8000	L_{WA}
1	Wlot	40	46	52	53	52	55	55	32	61
	Wylot	40	48	51	56	58	57	55	34	63
2	Wlot	40	44	49	51	52	50	48	30	58
	Wylot	41	46	49	54	58	52	48	31	61
3	Wlot	42	42	47	49	46	45	45	31	54
	Wylot	43	44	46	53	53	49	45	32	58
4	Wlot	35	41	47	48	47	50	50	27	56
	Wylot	35	43	46	51	53	52	50	29	59
5	Wlot	36	40	45	47	48	46	44	26	53
	Wylot	37	42	45	50	54	48	44	27	57
6	Wlot	38	38	43	45	42	41	41	27	50
	Wylot	39	40	42	49	49	45	41	28	53
7	Wlot	29	35	41	42	41	44	44	21	50
	Wylot	29	37	40	45	47	46	44	23	53
8	Wlot	30	34	39	41	42	40	38	20	47
	Wylot	31	36	39	44	48	42	38	21	51
9	Wlot	32	32	37	39	36	35	35	21	44
	Wylot	33	34	36	43	43	39	35	22	48
10	Wlot	26	32	38	39	38	41	41	18	46
	Wylot	26	34	37	42	44	43	41	20	49
11	Wlot	26	30	35	37	38	36	34	16	43
	Wylot	27	32	35	40	44	38	34	17	47
12	Wlot	28	28	33	35	32	31	31	17	40
	Wylot	29	30	32	39	39	35	31	18	44

CHARAKTERYSTYKI PRACY

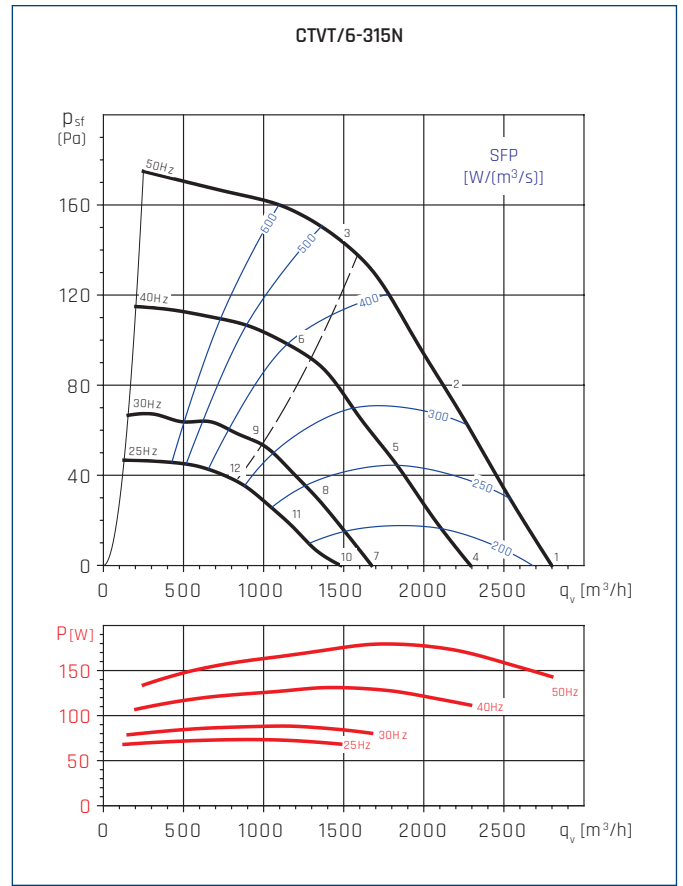
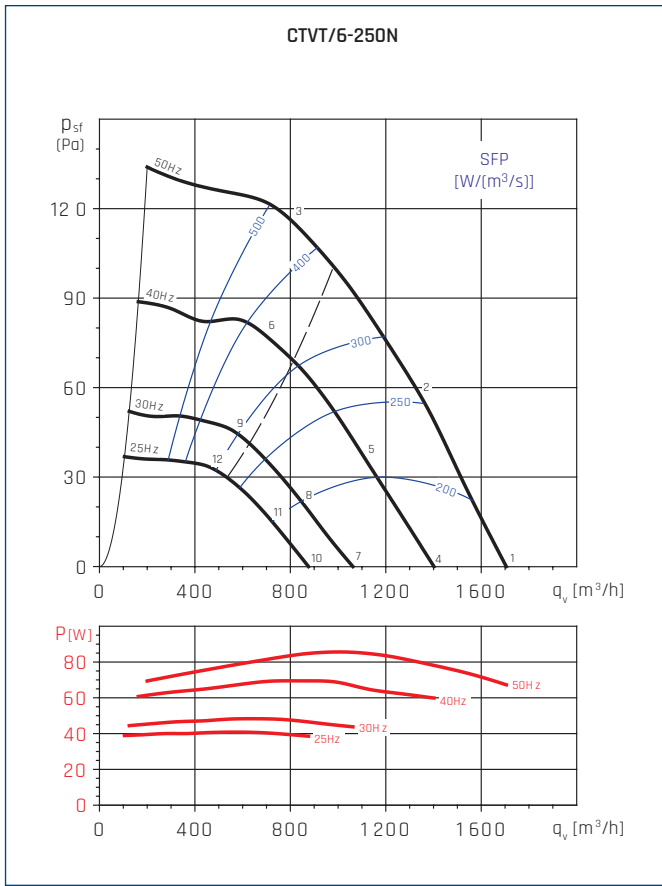

Poziom mocy akustycznej [dB(A)]

Punkt pracy		63	125	250	500	1000	2000	4000	8000	L_{WA}
1	Wlot	42	49	55	57	53	54	58	34	63
	Wylot	44	53	58	58	61	58	58	37	66
2	Wlot	43	47	53	55	52	50	52	33	60
	Wylot	46	51	56	56	59	53	52	35	63
3	Wlot	43	46	51	54	52	50	44	36	59
	Wylot	44	48	53	55	57	53	46	37	61
4	Wlot	38	45	51	53	49	50	54	30	59
	Wylot	40	49	54	54	57	54	54	33	62
5	Wlot	39	43	49	51	48	46	48	29	56
	Wylot	42	47	52	52	55	49	48	31	59
6	Wlot	39	42	47	50	48	46	40	32	54
	Wylot	40	44	49	51	53	49	42	33	57
7	Wlot	32	39	45	47	43	44	48	24	53
	Wylot	34	43	48	48	51	48	48	27	56
8	Wlot	33	37	43	45	42	40	42	23	50
	Wylot	36	41	46	46	49	43	42	25	53
9	Wlot	33	36	41	44	42	40	34	26	49
	Wylot	34	38	43	45	47	43	36	27	51
10	Wlot	28	35	41	43	39	40	44	20	49
	Wylot	30	39	44	44	47	44	44	23	52
11	Wlot	29	33	39	41	38	36	38	19	46
	Wylot	32	37	42	42	45	39	38	21	50
12	Wlot	29	32	37	40	38	36	30	22	45
	Wylot	30	34	39	41	43	39	32	23	48

Poziom mocy akustycznej [dB(A)]

Punkt pracy		63	125	250	500	1000	2000	4000	8000	L_{WA}
1	Wlot	46	55	61	61	59	61	64	43	69
	Wylot	47	58	63	64	64	64	63	44	71
2	Wlot	47	52	59	58	58	57	59	40	66
	Wylot	48	55	61	62	62	59	59	40	68
3	Wlot	46	48	53	55	56	56	57	40	63
	Wylot	47	50	56	58	60	57	57	41	65
4	Wlot	42	50	57	56	55	57	60	39	64
	Wylot	43	53	59	59	60	59	58	40	66
5	Wlot	42	48	54	54	53	53	55	35	61
	Wylot	44	50	56	58	58	54	54	36	64
6	Wlot	42	44	49	50	51	52	53	35	58
	Wylot	43	45	51	54	56	53	53	36	61
7	Wlot	36	44	51	50	49	51	54	33	58
	Wylot	37	47	53	54	54	53	52	34	61
8	Wlot	37	42	49	48	48	47	49	30	56
	Wylot	38	45	51	52	52	49	49	30	58
9	Wlot	36	38	43	44	45	46	47	30	53
	Wylot	37	40	45	48	50	47	47	30	55
10	Wlot	32	41	47	46	45	47	50	29	55
	Wylot	33	43	49	50	50	50	49	30	57
11	Wlot	33	39	45	45	44	43	46	26	52
	Wylot	34	41	47	48	49	45	45	27	54
12	Wlot	33	34	39	41	42	42	43	26	49
	Wylot	33	36	42	44	46	43	43	27	51

CHARAKTERYSTYKI PRACY

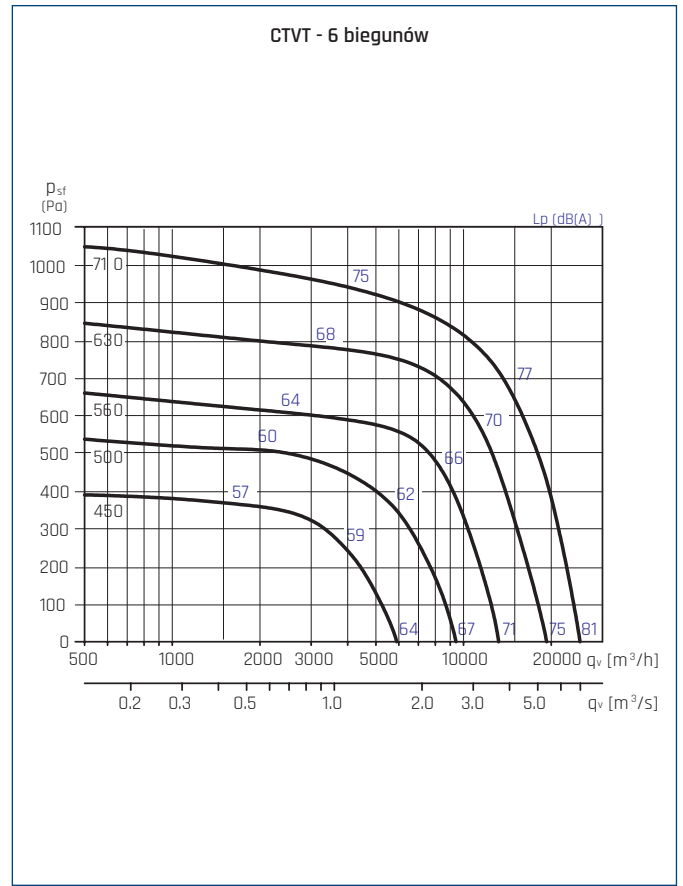
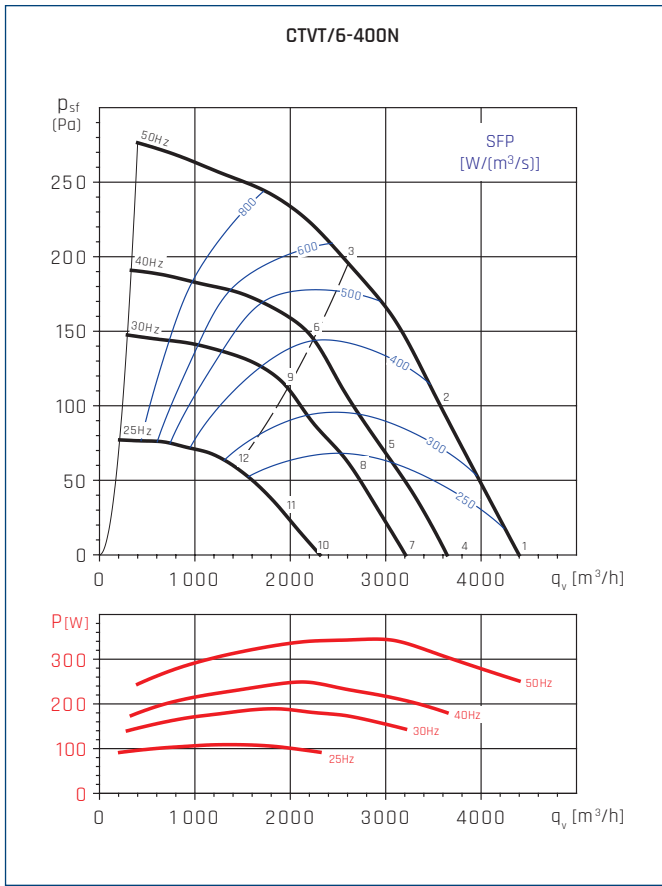

Poziom mocy akustycznej [dB(A)]

Punkt pracy		63	125	250	500	1000	2000	4000	8000	L_{WA}
1	Wlot	42	53	62	71	70	64	72	55	76
	Wylot	45	57	65	73	77	66	72	55	80
2	Wlot	44	53	62	70	66	64	67	53	74
	Wylot	46	56	63	71	72	65	67	54	76
3	Wlot	44	51	59	62	62	65	64	53	70
	Wylot	47	54	60	66	65	66	64	53	72
4	Wlot	38	49	58	67	66	60	68	51	72
	Wylot	41	53	61	69	73	62	68	51	76
5	Wlot	40	49	58	66	62	60	63	49	70
	Wylot	42	52	59	67	68	61	63	50	72
6	Wlot	41	48	56	59	59	62	61	50	67
	Wylot	44	51	57	63	62	63	61	50	68
7	Wlot	35	46	55	64	63	57	65	48	70
	Wylot	38	50	58	66	70	59	65	48	73
8	Wlot	38	47	56	64	60	58	61	47	67
	Wylot	40	50	57	65	66	59	61	48	70
9	Wlot	38	45	53	56	56	59	58	47	64
	Wylot	41	48	54	60	59	60	58	47	66
10	Wlot	28	39	48	57	56	50	58	41	63
	Wylot	31	43	51	59	63	52	58	41	66
11	Wlot	31	40	49	57	53	51	54	40	60
	Wylot	33	43	50	58	59	52	54	41	63
12	Wlot	31	38	46	49	49	52	51	40	57
	Wylot	34	41	47	53	52	53	51	40	59

CHARAKTERYSTYKI PRACY

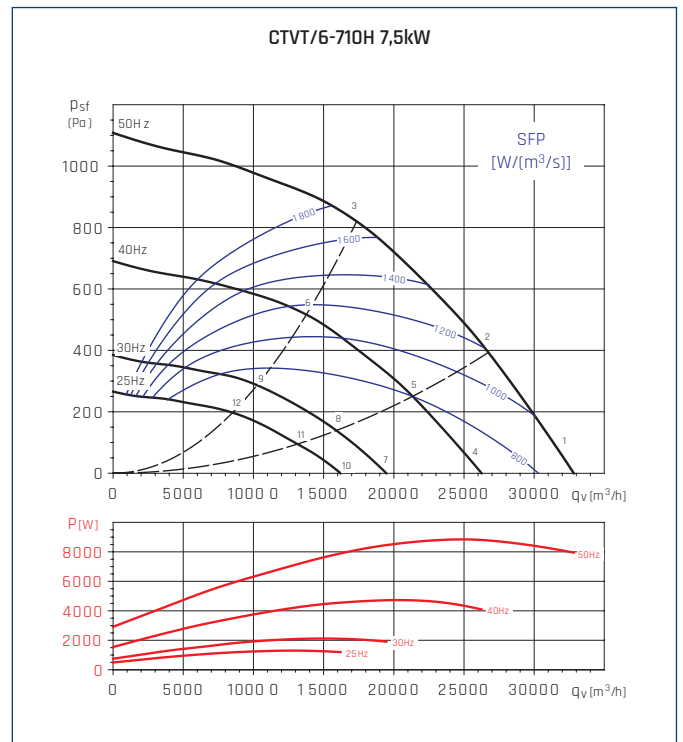
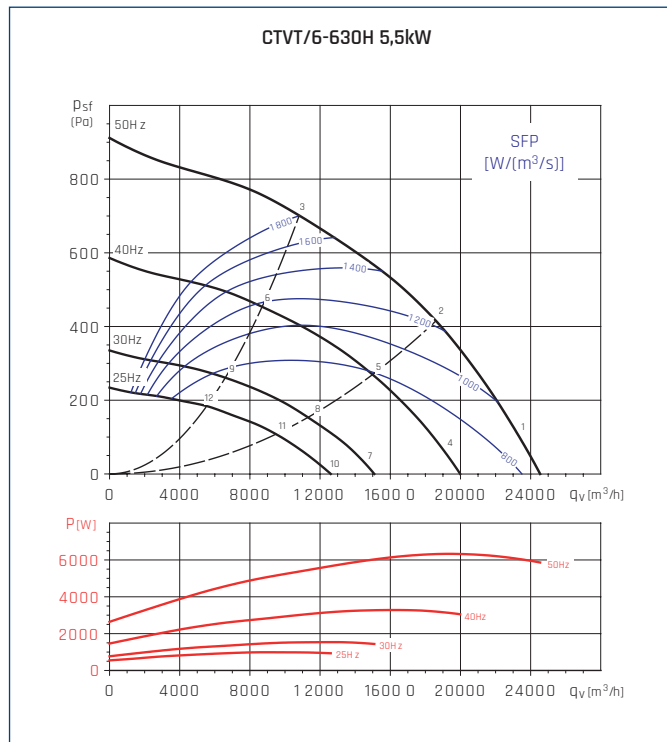
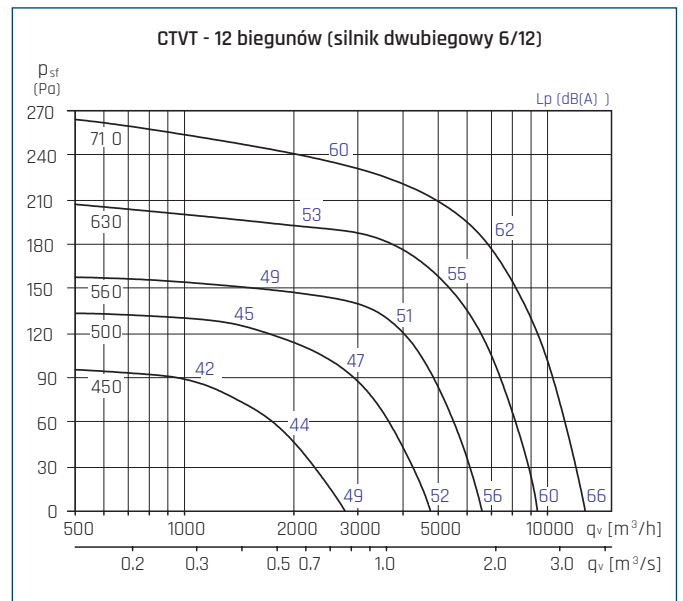
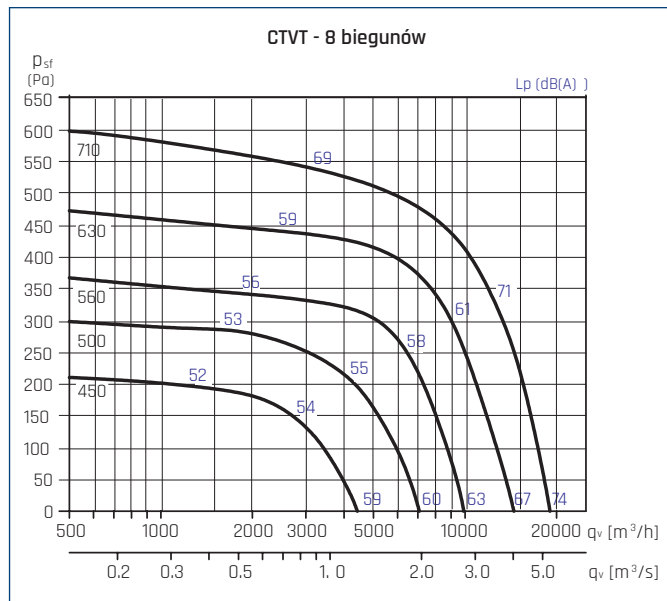

Poziom mocy akustycznej [dB(A)]

Punkt pracy		63	125	250	500	1000	2000	4000	8000	L _{WA}
1	Wylot	69	80	83	87	87	83	77	72	92
2	Wylot	67	79	82	86	86	81	75	69	91
3	Wylot	72	81	84	87	86	81	75	68	92
4	Wylot	64	75	78	82	82	78	72	67	87
5	Wylot	62	74	77	81	81	76	70	64	86
6	Wylot	67	76	79	82	81	76	70	63	87
7	Wylot	53	64	67	71	71	67	61	56	76
8	Wylot	51	63	66	70	70	65	59	53	75
9	Wylot	56	65	68	71	70	65	59	52	76
10	Wylot	38	49	52	56	56	52	46	41	61
11	Wylot	36	48	51	55	55	50	44	38	60
12	Wylot	41	50	53	56	55	50	44	37	61

Poziom mocy akustycznej [dB(A)]

Punkt pracy		63	125	250	500	1000	2000	4000	8000	L _{WA}
1	Wylot	72	85	91	91	89	86	81	75	96
2	Wylot	69	83	88	89	87	84	79	73	94
3	Wylot	72	84	90	90	87	83	78	73	95
4	Wylot	67	81	86	87	85	81	76	71	92
5	Wylot	64	78	83	84	82	79	74	68	89
6	Wylot	67	79	85	85	82	78	73	68	90
7	Wylot	56	70	75	76	74	70	65	60	81
8	Wylot	53	67	72	73	71	68	63	57	78
9	Wylot	56	68	74	74	71	67	62	57	79
10	Wylot	41	54	60	60	58	55	50	44	65
11	Wylot	38	52	57	58	56	53	48	42	63
12	Wylot	41	53	59	59	56	52	47	42	64

CHARAKTERYSTYKI PRACY

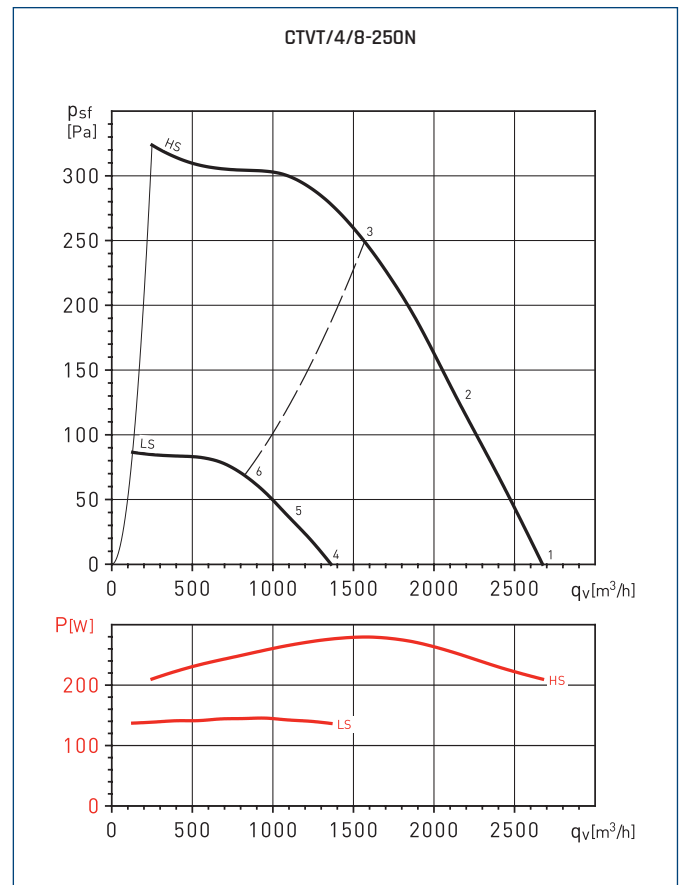
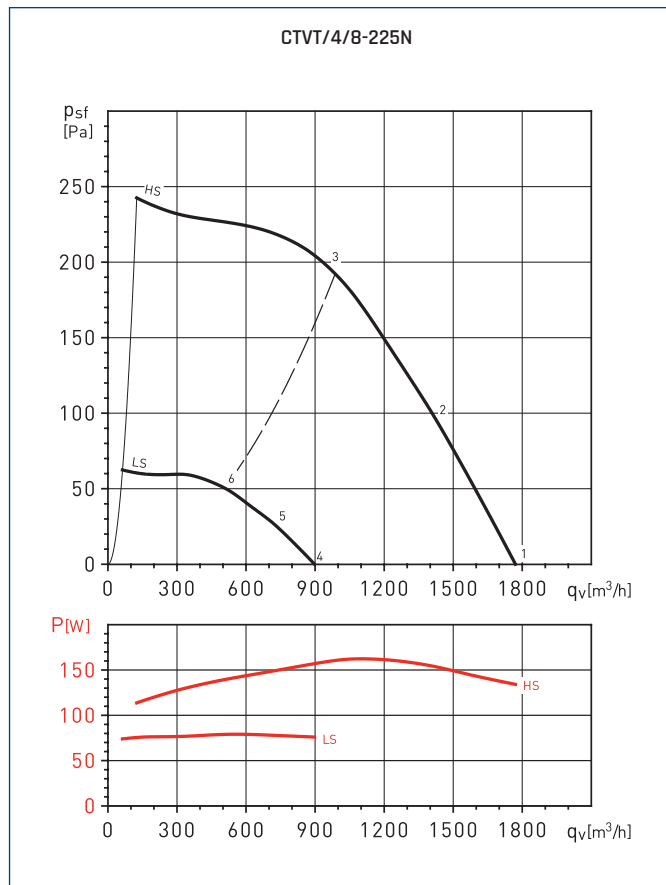

Poziom mocy akustycznej [dB(A)]

Punkt pracy		63	125	250	500	1000	2000	4000	8000	L _{WA}
1	Wlot	42	59	65	68	62	61	64	50	72
	Wylot	46	61	64	71	69	66	64	52	75
2	Wlot	42	56	63	67	60	58	57	45	70
	Wylot	42	58	62	70	68	64	58	48	74
3	Wlot	41	57	62	65	58	57	53	46	68
	Wylot	42	58	61	68	65	62	55	48	71
4	Wlot	28	45	51	54	48	47	50	36	58
	Wylot	32	47	50	57	55	52	50	38	61
5	Wlot	28	42	49	53	46	44	43	31	56
	Wylot	28	44	48	56	54	50	44	34	59
6	Wlot	26	42	47	50	43	42	38	31	53
	Wylot	27	43	46	53	50	47	40	33	56

Poziom mocy akustycznej [dB(A)]

Punkt pracy		63	125	250	500	1000	2000	4000	8000	L _{WA}
1	Wlot	46	62	67	69	63	66	66	59	74
	Wylot	47	65	70	70	70	70	67	58	77
2	Wlot	44	59	65	67	62	66	58	54	72
	Wylot	45	62	67	68	69	69	59	54	75
3	Wlot	43	57	63	66	63	62	56	52	70
	Wylot	45	61	66	67	69	66	60	53	74
4	Wlot	32	48	53	55	49	52	52	45	60
	Wylot	33	51	56	56	56	56	53	44	63
5	Wlot	30	45	51	53	48	52	44	40	58
	Wylot	31	48	53	54	55	55	45	40	61
6	Wlot	29	43	49	52	49	48	42	38	57
	Wylot	31	47	52	53	55	52	46	39	60

CHARAKTERYSTYKI PRACY

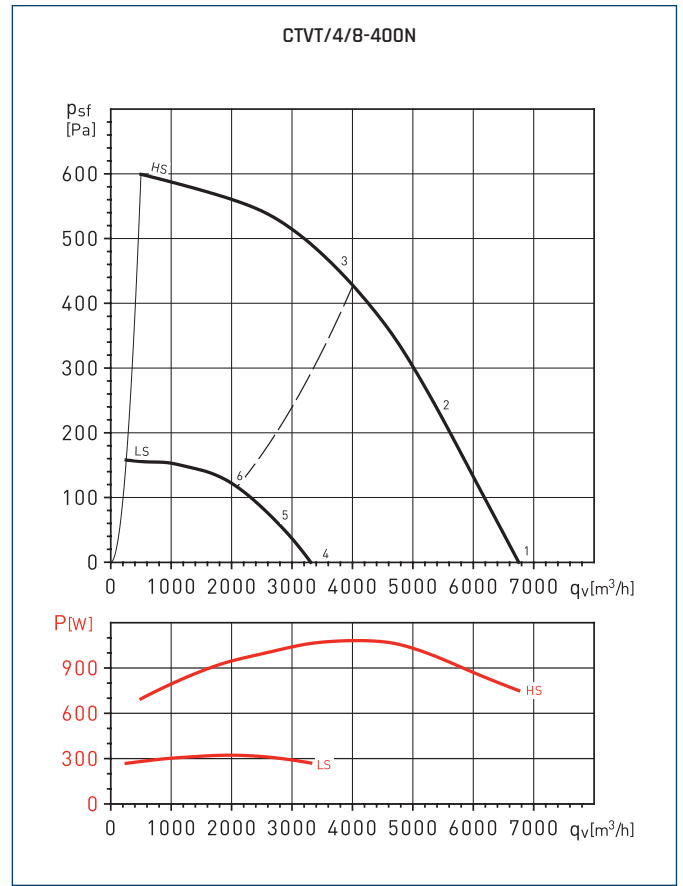
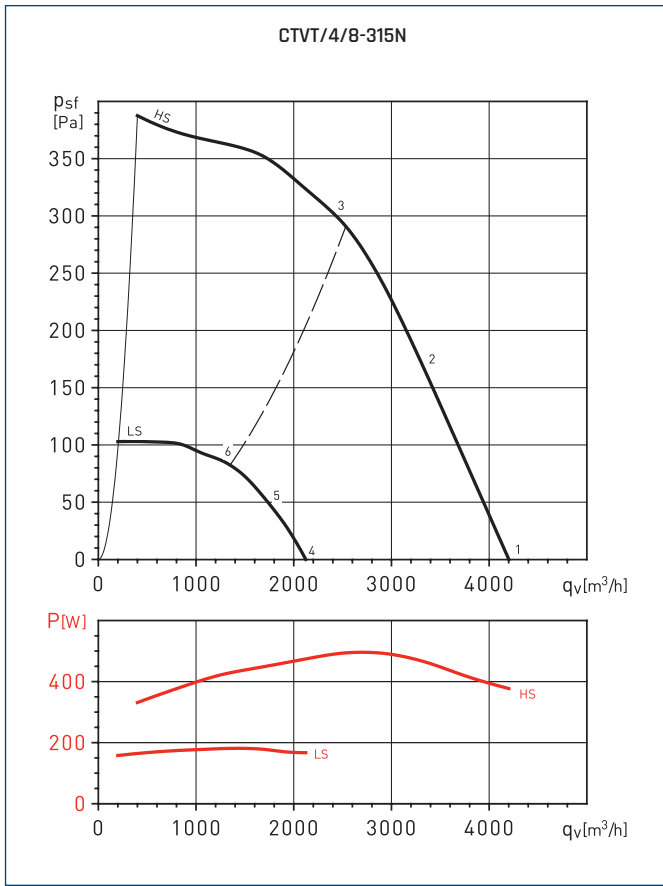

Poziom mocy akustycznej [dB(A)]

Punkt pracy		63	125	250	500	1000	2000	4000	8000	L_{WA}
1	Wlot	50	66	72	72	69	69	68	71	78
	Wylot	51	69	75	75	75	72	68	70	81
2	Wlot	48	63	69	69	67	66	62	63	75
	Wylot	49	65	72	73	73	69	63	63	79
3	Wlot	45	60	65	64	65	64	61	60	72
	Wylot	45	62	67	68	70	67	62	60	75
4	Wlot	36	51	58	58	55	55	54	57	64
	Wylot	37	55	61	61	61	58	54	56	67
5	Wlot	34	49	56	56	54	52	48	50	61
	Wylot	35	52	59	59	60	56	49	50	65
6	Wlot	32	46	51	51	52	51	48	46	58
	Wylot	32	49	54	55	56	54	49	46	61

Poziom mocy akustycznej [dB(A)]

Punkt pracy		63	125	250	500	1000	2000	4000	8000	L_{WA}
1	Wlot	43	62	71	71	84	75	70	75	86
	Wylot	58	71	74	76	87	81	74	75	89
2	Wlot	42	60	72	70	79	70	66	67	81
	Wylot	50	70	72	75	84	73	69	67	86
3	Wlot	43	61	70	67	68	69	67	63	76
	Wylot	47	67	70	72	73	71	69	64	79
4	Wlot	29	48	57	57	70	61	56	61	71
	Wylot	44	57	60	62	73	67	60	61	75
5	Wlot	28	46	58	56	65	56	52	53	67
	Wylot	36	56	58	61	70	59	55	53	71
6	Wlot	29	47	56	53	54	55	53	49	62
	Wylot	33	53	56	58	59	57	55	50	65

WYMIARY [mm]

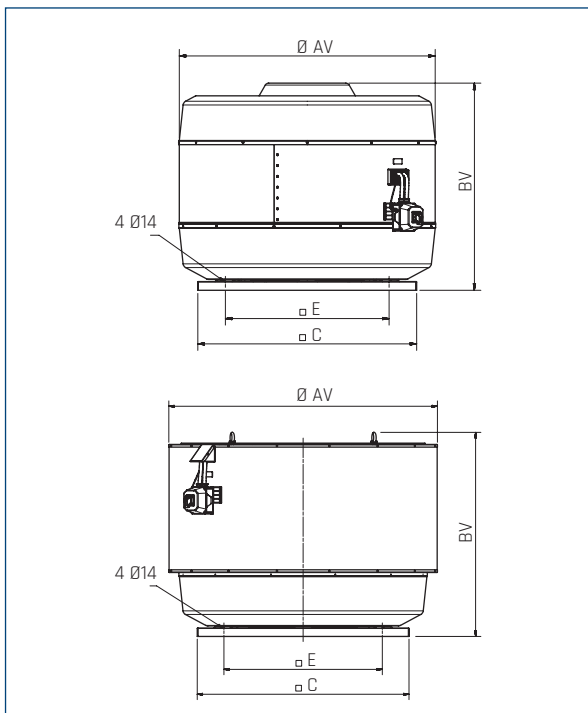
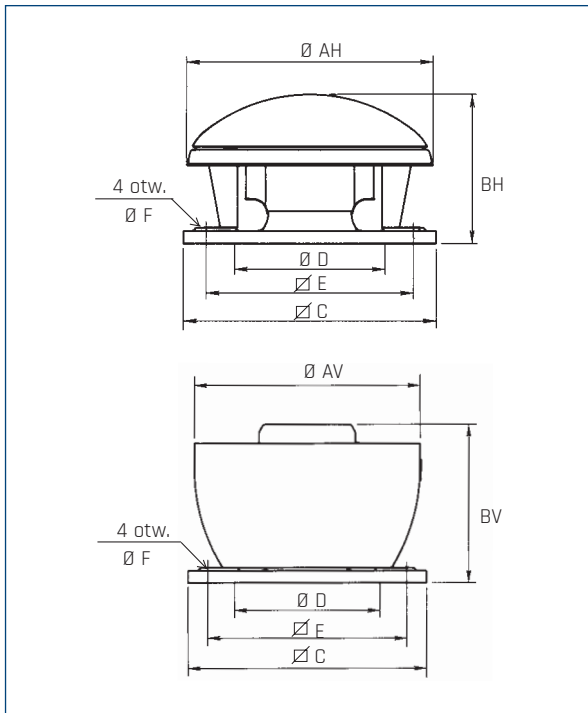

Typ	$\varnothing AH$	$\varnothing AV$	BH	BV		$\varnothing D$		$\varnothing F$	B
180N	415	431	296	378	300	212	245	10	35
200N	570	560	345	415	435	234	330	12	40
225N	570	560	382	453	435	261	330	12	40
250N	778	750	432	504	560	289	450	12	40
315N	778	750	472	545	560	326	450	12	40
400N	850	857	540	605	630	420	535	12	40
450	962	950	713	741	710	500	590	14	-
500	1214	1216	824	832	905	630	750	14	-
560	1214	1216	874	832	905	630	750	14	-
630	1336	1327	1029	1053	1100	710	840	14	-
630H	1336	1332	1044	1067	1100	710	840	14	-
710	1336	1485	1127	1161	1100	710	840	14	-
710H	1336	1490	1139	1162	1100	710	840	14	-
CTVT/4-632-5,5	-	1216	-	930	905	-	750	-	-
CTVT/4-631-7,5	-	1216	-	930	905	-	750	-	-
CTVT/4-712-11	-	1485	-	1146	1270	-	950	-	-
CTVT/4-711-15	-	1485	-	1188	1270	-	950	-	-
CTVT/4-802-18,5	-	1485	-	1207	1270	-	950	-	-
CTVT/4-801-22	-	1485	-	1225	1270	-	950	-	-
CTVT/4-902-30	-	1485	-	1345	1270	-	950	-	-
CTVT/4-632-5,5-INS	-	1342	-	978	905	-	750	-	-
CTVT/4-631-7,5-INS	-	1342	-	978	905	-	750	-	-
CTVT/4-712-11-INS	-	1611	-	1163	1270	-	950	-	-
CTVT/4-711-15-INS	-	1611	-	1250	1270	-	950	-	-
CTVT/4-802-18,5-INS	-	1611	-	1274	1270	-	950	-	-
CTVT/4-801-22-INS	-	1611	-	1292	1270	-	950	-	-
CTVT/4-902-30-INS	-	1611	-	1432	1270	-	950	-	-

AKCESORIA MONTAŻOWE



podstawa dachowa RS	podstawa dachowa JBS	podstawa tłumiąca RSA	podstawa tłumiąca JAA	złącze P	złącze JPA	kłapa zwrotna KZD	kłapa zwrotna JCA	złącze p-drg. ZDPO	złącze p-drg. JAE
króciec K	króciec JBR								

AKCESORIA MONTAŻOWE

1	2		3		4	
Wentylator	podstawa dachowa standard F400		podstawa dachowa tłumiąca standard F400		złącze standard F400	
140	RS 300	JBS 300	RSA 300	JAA 300	P 300	JPA 300
180	RS 300	JBS 300	RSA 300	JAA 300	P 300	JPA 300
200	RS 435	JBS 435	RSA 435	JAA 435	P 435	JPA 435
225	RS 435	JBS 435	RSA 435	JAA 435	P 435	JPA 435
250	RS 560	JBS 560	RSA 560	JAA 560	P 560	JPA 560
315	RS 560	JBS 560	RSA 560	JAA 560	P 560	JPA 560
400	RS 630	JBS 630	RSA 630	JAA 630	P 630	JPA 630
450	RS 710	JBS 710	RSA 710	JAA 710	P 710	JPA 710
500	RS 905	JBS 905	RSA 905	JAA 905	P 905	JPA 905
560	RS 905	JBS 905	RSA 905	JAA 905	P 905	JPA 905
630	RS 1100	JBS 1100	RSA 1100	JAA 1100	P 1100	JPA 1100
710	RS 1100	JBS 1100	RSA 1100	JAA 1100	P 1100	JPA 1100
632	RS 905	JBS 905	RSA 905	JAA 905	P 905	JPA 905
631	RS 905	JBS 905	RSA 905	JAA 905	P 905	JPA 905
712	RS 1250	RS 435	RSA 1250	-	P 1250	JPA 1250
711	RS 1250	RS 435	RSA 1250	-	P 1250	JPA 1250
802	RS 1250	RS 435	RSA 1250	-	P 1250	JPA 1250
801	RS 1250	RS 435	RSA 1250	-	P 1250	JPA 1250

1	5		6		7	
Wentylator	klapa zwrotna standard F400		złącze przeciwdrganiowe standard F400		króciec standard F400	
140	KZD 300	JCA 300	ZDPO 300	JAE 300	K 300	JBR 300
180	KZD 300	JCA 300	ZDPO 300	JAE 300	K 300	JBR 300
200	KZD 435	JCA 435	ZDPO 435	JAE 435	K 435	JBR 435
225	KZD 435	JCA 435	ZDPO 435	JAE 435	K 435	JBR 435
250	KZD 560-N	JCA 560-N	ZDPO 560	JAE 560	K 560	JBR 560
315	KZD 560-N	JCA 560-N	ZDPO 560	JAE 560	K 560	JBR 560
400	KZD 630-N	JCA 630-N	ZDPO 630	JAE 630	K 630	JBR 630
450	KZD 710-N	JCA 710-N	ZDPO 710	JAE 710	K 710	JBR 710
500	KZD 905-N	JCA 905-N	ZDPO 905	JAE 905	K 905	JBR 905
560	KZD 905-N	JCA 905-N	ZDPO 905	JAE 905	K 905	JBR 905
630	KZD 1100-N	JCA 1100-N	ZDPO 1100	JAE 1100	K 1100	JBR 1100
710	KZD 1100-N	JCA 1100-N	ZDPO 1100	JAE 1100	K 1100	JBR 1100
632	KZD 905-N	JCA 905-N	ZDPO 905	JAE 905	K 905	JBR 905
631	KZD 905-N	JCA 905-N	ZDPO 905	JAE 905	K 905	JBR 905
712	KZD 1250	JCA 1250	-	-	K 1250	JBR 1250
711	KZD 1250	JCA 1250	-	-	K 1250	JBR 1250
802	KZD 1250	JCA 1250	-	-	K 1250	JBR 1250
801	KZD 1250	JCA 1250	-	-	K 1250	JBR 1250

Numery artykułów

JAA 1100	43525199	JBR 630	43525440	JPA 1250	43525280	KZD 560-N	43527320	RS 905	43526060
JAA 300	43525175	JBR 710	43525450	JPA 300	43525210	KZD 630-N	43527330	RSA 1100	43526170
JAA 435	43525180	JBR 905	43525460	JPA 435	43525220	KZD 710-N	43527340	RSA 1250	43526180
JAA 560	43525185	JBS 1100	43525160	JPA 560	43525230	KZD 905-N	43527350	RSA 300	43526110
JAA 630	43525190	JBS 300	43525110	JPA 630	43525240	P 1100	43526360	RSA 435	43526120
JAA 710	43525195	JBS 435	43525120	JPA 710	43525250	P 1250	43526370	RSA 560	43526130
JAA 905	43525198	JBS 560	43525130	JPA 905	43525260	P 300	43526300	RSA 630	43526140
JAE 1100	43525570	JBS 630	43525140	K 1100	43526460	P 435	43526310	RSA 710	43526150
JAE 300	43525510	JBS 710	43525145	K 1250	43526470	P 560	43526320	RSA 905	43526160
JAE 435	43525520	JBS 905	43525150	K 300	43526400	P 630	43526330	ZDPO 1100	43527460
JAE 560	43525530	JCA 1100-N	43525370	K 435	43526410	P 710	43526340	ZDPO 300	43527400
JAE 630	43525540	JCA 1250	43525380	K 560	43526420	P 905	43526350	ZDPO 435	43527410
JAE 710	43525550	JCA 300	43525310	K 630	43526430	RS 1100	43526070	ZDPO 560	43527420
JAE 905	43525560	JCA 435	43525320	K 710	43526440	RS 1250	43526080	ZDPO 630	43527430
JBR 1100	43525470	JCA 560-N	43525330	K 905	43526450	RS 300	43526010	ZDPO 710	43527440
JBR 1250	43525480	JCA 630-N	43525340	KZD 1100-N	43527360	RS 435	43526020	ZDPO 905	43527450
JBR 300	43525410	JCA 710-N	43525350	KZD 1250	43527370	RS 560	43526030		
JBR 435	43525420	JCA 905-N	43525360	KZD 300	43527300	RS 630	43526040		
JBR 560	43525430	JPA 1100	43525270	KZD 435	43527310	RS 710	43526050		

AKCESORIA ELEKTRYCZNE - ZASILANIE JEDNOFAZOWE

Wentylator	termostat ścienny	termostat	czujnik temperatury do TK-21	czujnik zanieczyszczeń	czujnik wilgotności	Czujnik CO 2/VOC/RH
	TS	TK-21		SQA	HIG-2	Airsens
CTHB/4-180N	TS	TK-21	Czujnik TK-21	SQA	HIG-2	AirSens
CTHB/4-200N	TS	TK-21	Czujnik TK-21	SQA	HIG-2	AirSens
CTHB/4-225N	TS	TK-21	Czujnik TK-21	SQA	HIG-2	-
CTHB/4-250N	TS	TK-21	Czujnik TK-21	SQA	HIG-2	-
CTHB/4-315N	TS + DILM7-10	TK-21	Czujnik TK-21	SQA + DILM7-10	HIG-2	-
CTHB/4-400N	TS + DILM7-10	TK-21	Czujnik TK-21	SQA + DILM7-10	HIG-2	-
CTHB/6-200N	TS	TK-21	Czujnik TK-21	SQA	HIG-2	AirSens
CTHB/6-225N	TS	TK-21	Czujnik TK-21	SQA	HIG-2	AirSens
CTHB/6-250N	TS	TK-21	Czujnik TK-21	SQA	HIG-2	AirSens
CTHB/6-315N	TS	TK-21	Czujnik TK-21	SQA	HIG-2	AirSens
CTHB/6-400N	TS	TK-21	Czujnik TK-21	SQA	HIG-2	-
CTVB/4-180N	TS	TK-21	Czujnik TK-21	SQA	HIG-2	AirSens
CTVB/4-200N	TS	TK-21	Czujnik TK-21	SQA	HIG-2	AirSens
CTVB/4-225N	TS	TK-21	Czujnik TK-21	SQA	HIG-2	AirSens
CTVB/4-250N	TS	TK-21	Czujnik TK-21	SQA	HIG-2	-
CTVB/4-315N	TS	TK-21	Czujnik TK-21	SQA	HIG-2	-
CTVB/4-400N	TS	TK-21	Czujnik TK-21	SQA	HIG-2	-
CTVB/6-200N	TS	TK-21	Czujnik TK-21	SQA	HIG-2	AirSens
CTVB/6-225N	TS	TK-21	Czujnik TK-21	SQA	HIG-2	AirSens
CTVB/6-250N	TS	TK-21	Czujnik TK-21	SQA	HIG-2	AirSens
CTVB/6-315N	TS	TK-21	Czujnik TK-21	SQA + DILM7-10	HIG-2	AirSens
CTVB/6-400N	TS + DILM7-10	TK-21	Czujnik TK-21	SQA + DILM7-10	HIG-2	-

Wentylator	regulator tyrystorowy						11-stopniowy regulator tyrystorowy
	REB N	REB NE	TLR	TLR TE	RND-1	ERV	IRF-900
CTHB/4-180N	REB-1N	REB-1NE	TLR 15DS	TLR 3 TE	RND-1	ERV-3	IRF-900
CTHB/4-200N	REB-1N	REB-1NE	TLR 15DS	TLR 3 TE	RND-1	ERV-3	IRF-900
CTHB/4-225N	REB-2,5N	REB-2,5NE	TLR 25DS	TLR 3 TE	RND-1	ERV-3	IRF-900
CTHB/4-250N	REB-2,5N	REB-2,5NE	TLR 25DS	TLR 3 TE	RND-1	ERV-3	IRF-900
CTHB/4-315N	REB 5		-	TLR 5 TE	-	ERV-5	-
CTHB/4-400N	REB 10		-	TLR 10 TE	-	ERV-10	-
CTHB/6-200N	REB-1N	REB-1NE	TLR 15DS	TLR 3 TE	-	ERV-3	-
CTHB/6-225N	REB-1N	REB-1NE	TLR 15DS	TLR 3 TE	RND-1	ERV-3	-
CTHB/6-250N	REB-1N	REB-1NE	TLR 15DS	TLR 3 TE	RND-1	ERV-3	-
CTHB/6-315N	REB-1N	REB-1NE	TLR 15DS	TLR 3 TE	RND-1	ERV-3	-
CTHB/6-400N	REB-2,5N	REB-2,5NE	TLR 25DS	TLR 3 TE	RND-1	ERV-3	-
CTVB/4-180N	REB-1N	REB-1NE	TLR 15DS	TLR 3 TE	RND-1	ERV-3	-
CTVB/4-200N	REB-1N	REB-1NE	TLR 15DS	TLR 3 TE	RND-1	ERV-3	-
CTVB/4-225N	REB-2,5N	REB-2,5NE	TLR 25DS	TLR 3 TE	RND-1	ERV-3	-
CTVB/4-250N	REB-2,5N	REB-2,5NE	TLR 25DS	TLR 3 TE	RND-1	ERV-3	-
CTVB/4-315N	REB 5		-	TLR 5 TE	-	ERV-5	-
CTVB/4-400N	REB 10		-	TLR 10 TE	-	ERV-10	-
CTVB/6-200N	REB-1N	REB-1NE	TLR 15DS	TLR 3 TE	RND-1	ERV-3	-
CTVB/6-225N	REB-1N	REB-1NE	TLR 15DS	TLR 3 TE	RND-1	ERV-3	-
CTVB/6-250N	REB-1N	REB-1NE	TLR 15DS	TLR 3 TE	RND-1	ERV-3	-
CTVB/6-315N	REB-1N	REB-1NE	TLR 15DS	TLR 3 TE	RND-1	ERV-3	-
CTVB/6-400N	REB-2,5N	REB-2,5NE	TLR 25DS	TLR 3 TE	RND-1	ERV-3	-

-

AKCESORIA ELEKTRYCZNE - ZASILANIE JEDNOFAZOWE

Wentylator	regulator transformatorowy			regulator transformatorowy dwunastawowy	rozłącznik serwisowy
	RMB	RVS	RVS-A	SC2A	R-S 1-F + SP, 16A
CTHB/4-180N	RMB 1,5	RVS 1,5	RVS-A 1,5	SC2A1-15L25	R-S 1-F + SP, 16A
CTHB/4-200N	RMB 1,5	RVS 1,5	RVS-A 1,5	SC2A1-15L25	R-S 1-F + SP, 16A
CTHB/4-225N	RMB 1,5	RVS 1,5	RVS-A 1,5	SC2A1-15L25	R-S 1-F + SP, 16A
CTHB/4-250N	RMB 3,5	RVS 3	RVS-A 3,0	SC2A1-25L25	R-S 1-F + SP, 16A
CTHB/4-315N	RMB 3,5	RVS 5	RVS-A 5,0	SC2A1-35L25	R-S 1-F + SP, 16A
CTHB/4-400N	RMB 8	RVS 7	RVS-A 7,0	SC2A1-75L25	R-S 1-F + SP, 16A
CTHB/6-200N	RMB 1,5	RVS 1,5	RVS-A 1,5	SC2A1-15L25	R-S 1-F + SP, 16A
CTHB/6-225N	RMB 1,5	RVS 1,5	RVS-A 1,5	SC2A1-15L25	R-S 1-F + SP, 16A
CTHB/6-250N	RMB 1,5	RVS 1,5	RVS-A 1,5	SC2A1-15L25	R-S 1-F + SP, 16A
CTHB/6-315N	RMB 1,5	RVS 1,5	RVS-A 1,5	SC2A1-15L25	R-S 1-F + SP, 16A
CTHB/6-400N	RMB 3,5	RVS 3	RVS-A 3,0	SC2A1-25L25	R-S 1-F + SP, 16A
CTVB/4-180N	RMB 1,5	RVS 1,5	RVS-A 1,5	SC2A1-15L25	R-S 1-F + SP, 16A
CTVB/4-200N	RMB 1,5	RVS 1,5	RVS-A 1,5	SC2A1-15L25	R-S 1-F + SP, 16A
CTVB/4-225N	RMB 1,5	RVS 1,5	RVS-A 1,5	SC2A1-15L25	R-S 1-F + SP, 16A
CTVB/4-250N	RMB 3,5	RVS 3	RVS-A 3,0	SC2A1-25L25	R-S 1-F + SP, 16A
CTVB/4-315N	RMB 3,5	RVS 5	RVS-A 5,0	SC2A1-35L25	R-S 1-F + SP, 16A
CTVB/4-400N	RMB 8	RVS 7	RVS-A 7,0	SC2A1-75L25	R-S 1-F + SP, 16A
CTVB/6-200N	RMB 1,5	RVS 1,5	RVS-A 1,5	SC2A1-15L25	R-S 1-F + SP, 16A
CTVB/6-225N	RMB 1,5	RVS 1,5	RVS-A 1,5	SC2A1-15L25	R-S 1-F + SP, 16A
CTVB/6-250N	RMB 1,5	RVS 1,5	RVS-A 1,5	SC2A1-15L25	R-S 1-F + SP, 16A
CTVB/6-315N	RMB 1,5	RVS 1,5	RVS-A 1,5	SC2A1-15L25	R-S 1-F + SP, 16A
CTVB/6-400N	RMB 3,5	RVS 3	RVS-A 3,0	SC2A1-25L25	R-S 1-F + SP, 16A

AKCESORIA ELEKTRYCZNE - ZASILANIE TRÓJFAZOWE

Wentylator	termostat ścienny	termostat kanałowy	regulator transformatorowy	regulator transformatorowy dwunastawowy	falownik	rozłącznik serwisowy	przełącznik biegów
	TS	TK-1	RMT	SC2A4			
CTHT/4-180N	TS + DILM7-10	TK-21 + DILM7-10	RMT 1,5	SC2A4-15L55	L 0,4 kW	R-S 3-F + SP, 10A	-
CTHT/4-200N	TS + DILM7-10	TK-21 + DILM7-10	RMT 1,5	SC2A4-15L55	L 0,4 kW	R-S 3-F + SP, 10A	-
CTHT/4-225N	TS + DILM7-10	TK-21 + DILM7-10	RMT 1,5	SC2A4-15L55	L 0,4 kW	R-S 3-F + SP, 10A	-
CTHT/4-250N	TS + DILM7-10	TK-21 + DILM7-10	RMT 1,5	SC2A4-15L55	L 0,4 kW	R-S 3-F + SP, 10A	-
CTHT/4-315N	TS + DILM7-10	TK-21 + DILM7-10	RMT 1,5	SC2A4-15L55	L 0,4 kW	R-S 3-F + SP, 10A	-
CTHT/4-400N	TS + DILM7-10	TK-21 + DILM7-10	RMT 2,5	SC2A4-25L55	L 0,75 kW	R-S 3-F + SP, 10A	-
CTHT/4-450	TS + DILM7-10	TK-21 + DILM7-10	RMT 5	SC2A4-60L55	L 2,2 kW	R-S 3-F + SP, 10A	-
CTHT/6-200N	TS + DILM7-10	TK-21 + DILM7-10	RMT 1,5	SC2A4-15L55	L 0,4 kW	R-S 3-F + SP, 10A	-
CTHT/6-225N	TS + DILM7-10	TK-21 + DILM7-10	RMT 1,5	SC2A4-15L55	L 0,4 kW	R-S 3-F + SP, 10A	-
CTHT/6-250N	TS + DILM7-10	TK-21 + DILM7-10	RMT 1,5	SC2A4-15L55	L 0,4 kW	R-S 3-F + SP, 10A	-
CTHT/6-315N	TS + DILM7-10	TK-21 + DILM7-10	RMT 1,5	SC2A4-15L55	L 0,4 kW	R-S 3-F + SP, 10A	-
CTHT/6-400N	TS + DILM7-10	TK-21 + DILM7-10	RMT 1,5	SC2A4-15L55	L 0,4 kW	R-S 3-F + SP, 10A	-
CTHT/6-450	TS + DILM7-10	TK-21 + DILM7-10	RMT 5	SC2A4-40L55	L 1,5 kW	R-S 3-F + SP, 10A	-
CTHT/6-500	TS + DILM7-10	TK-21 + DILM7-10	RMT 5	SC2A4-40L55	L 2,2 kW	R-S 3-F + SP, 10A	-
CTHT/6-560	TS + DILM7-10	TK-21 + DILM7-10	RMT 8	SC2A4-60L55	L 2,2 kW	R-S 3-F + SP, 10A	-
CTHT/6-630	TS + DILM9-10	TK-21 + DILM9-10	RMT 12	SC2A4-110L55	L 4,0 kW	R-S 3-F + SP, 10A	-
CTHT/6-630H	TS + DILM15-10	TK-21 + DILM15-10	-	-	L 7,5 kW	R-S 3-F + SP, 16A	-
CTHT/6-710	TS + DILM15-10	TK-21 + DILM15-10	-	-	L 7,5 kW	R-S 3-F + SP, 16A	-
CTHT/6-710H	TS + DILM25-10	TK-21 + DILM25-10	-	-	L 7,5 kW	R-S 3-F + SP, 16A	-
CTHT/8-450	TS + DILM7-10	TK-21 + DILM7-10	RMT 2,5	SC2A4-25L55	L 0,75 kW	R-S 3-F + SP, 10A	-
CTHT/8-500	TS + DILM7-10	TK-21 + DILM7-10	RMT 2,5	SC2A4-25L55	L 0,75 kW	R-S 3-F + SP, 10A	-
CTHT/8-560	TS + DILM7-10	TK-21 + DILM7-10	RMT 5	SC2A4-40L55	L 1,5 kW	R-S 3-F + SP, 10A	-
CTHT/8-630	TS + DILM7-10	TK-21 + DILM7-10	RMT 5	SC2A4-60L55	L 2,2 kW	R-S 3-F + SP, 10A	-
CTHT/8-710	TS + DILM9-10	TK-21 + DILM9-10	RMT 8	SC2A4-80L55	L 4,0 kW	R-S 3-F + SP, 10A	-
CTHT/4/8-225N	TS + DILM7-10	TK-21 + DILM7-10	-	-	-	R-S 3-F + SP, 10A	-
CTHT/4/8-250N	TS + DILM7-10	TK-21 + DILM7-10	-	-	-	R-S 3-F + SP, 10A	-

AKCESORIA ELEKTRYCZNE - ZASILANIE TRÓJFAZOWE

Wentylator	termostat ścienny	termostat kanałowy	regulator transformatorowy	regulator transformatorowy	falownik	rozłącznik serwisowy	przełącznik biegów
	TS	TK-1	RMT	SC2A4			
CTHT/4/8-315N	TS + DILM7-10	TK-21 + DILM7-10	-	-	-	R-S 3-F + SP, 10A	0-Y-YY
CTHT/4/8-400N	TS + DILM7-10	TK-21 + DILM7-10	-	-	-	R-S 3-F + SP, 10A	0-Y-YY
CTHT/4/8-450	TS + DILM7-10	TK-21 + DILM7-10	-	-	-	R-S 3-F + SP, 10A	0-Y-YY
CTHT/6/12-450	TS + DILM7-10	TK-21 + DILM7-10	-	-	-	R-S 3-F + SP, 10A	0-Y-YY
CTHT/6/12-500	TS + DILM7-10	TK-21 + DILM7-10	-	-	-	R-S 3-F + SP, 10A	0-Y-YY
CTHT/6/12-560	TS + DILM7-10	TK-21 + DILM7-10	-	-	-	R-S 3-F + SP, 10A	0-Y-YY
CTHT/6/12-630	TS + DILM7-10	TK-21 + DILM7-10	-	-	-	R-S 3-F + SP, 10A	0-Y-YY
CTHT/6/12-710	TS + DILM7-10	TK-21 + DILM7-10	-	-	-	R-S 3-F + SP, 10A	0-Y-YY
CTVT/4-180N	TS + DILM7-10	TK-21 + DILM7-10	RMT 1,5	SC2A4-15L55	L 0,4 kW	R-S 3-F + SP, 10A	
CTVT/4-200N	TS + DILM7-10	TK-21 + DILM7-10	RMT 1,5	SC2A4-15L55	L 0,4 kW	R-S 3-F + SP, 10A	
CTVT/4-225N	TS + DILM7-10	TK-21 + DILM7-10	RMT 1,5	SC2A4-15L55	L 0,4 kW	R-S 3-F + SP, 10A	
CTVT/4-250N	TS + DILM7-10	TK-21 + DILM7-10	RMT 1,5	SC2A4-15L55	L 0,4 kW	R-S 3-F + SP, 10A	
CTVT/4-315N	TS + DILM7-10	TK-21 + DILM7-10	RMT 1,5	SC2A4-15L55	L 0,4 kW	R-S 3-F + SP, 10A	
CTVT/4-400N	TS + DILM7-10	TK-21 + DILM7-10	RMT 5	SC2A4-25L55	L 0,75 kW	R-S 3-F + SP, 10A	
CTVT/4-450	TS + DILM7-10	TK-21 + DILM7-10	RMT 5	SC2A4-60L55	L 2,2 kW	R-S 3-F + SP, 10A	
CTVT/4-632 HP 5,5kW	TS + DILM12-10	TK-21 + DILM12-10	RMT 12	SC2A4-110L55	L 5,5 kW	R-S 3-F + SP, 16A	
CTVT/4-631 HP 7,5kW	TS + DILM15-10	TK-21 + DILM15-10	-	-	L 7,5 kW	R-S 3-F + SP, 16A	
CTVT/4-712 HP 11kW	TS + DILM25-10	TK-21 + DILM25-10	-	-	L 11,0 kW	R-S 3-F + SP, 25A	
CTVT/4-711 HP 15kW	TS + DILM32-10	TK-21 + DILM32-10	-	-	L 15,0 kW	R-S 3-F + SP, 40A	
CTVT/4-802 HP 18,5kW	TS + DILM40-10	TK-21 + DILM40-10	-	-	L 18,5 kW	R-S 3-F + SP, 40A	
CTVT/4-801 HP 22kW	TS + DILM50-10	TK-21 + DILM50-10	-	-	L 22,0kW	R-S 3-F + SP, 63A	
CTVT/4-632 5,5kW INS	TS + DILM12-10	TK-21 + DILM12-10	-	-	L 5,5 kW	R-S 3-F + SP, 16A	
CTVT/4-631 7,5kW INS	TS + DILM15-10	TK-21 + DILM15-10	-	-	L 7,5 kW	R-S 3-F + SP, 16A	
CTVT/4-712 11kW INS	TS + DILM25-10	TK-21 + DILM25-10	-	-	L 11,0 kW	R-S 3-F + SP, 25A	
CTVT/4-711 15kW INS	TS + DILM32-10	TK-21 + DILM32-10	-	-	L 15,0 kW	R-S 3-F + SP, 40A	
CTVT/4-802 18,5kW INS	TS + DILM40-10	TK-21 + DILM40-10	-	-	L 18,5 kW	R-S 3-F + SP, 40A	
CTVT/4-801 22kW INS	TS + DILM50-10	TK-21 + DILM50-10	-	-	L 22,0kW	R-S 3-F + SP, 63A	
CTVT/6-200N	TS + DILM7-10	TK-21 + DILM7-10	RMT 1,5	SC2A4-15L55	L 0,4 kW	R-S 3-F + SP, 10A	
CTVT/6-225N	TS + DILM7-10	TK-21 + DILM7-10	RMT 1,5	SC2A4-15L55	L 0,4 kW	R-S 3-F + SP, 10A	
CTVT/6-250N	TS + DILM7-10	TK-21 + DILM7-10	RMT 1,5	SC2A4-15L55	L 0,4 kW	R-S 3-F + SP, 10A	
CTVT/6-315N	TS + DILM7-10	TK-21 + DILM7-10	RMT 1,5	SC2A4-15L55	L 0,4 kW	R-S 3-F + SP, 10A	
CTVT/6-400N	TS + DILM7-10	TK-21 + DILM7-10	RMT 1,5	SC2A4-15L55	L 0,4 kW	R-S 3-F + SP, 10A	
CTVT/6-450	TS + DILM7-10	TK-21 + DILM7-10	RMT 5	SC2A4-40L55	L 1,5 kW	R-S 3-F + SP, 10A	
CTVT/6-500	TS + DILM7-10	TK-21 + DILM7-10	RMT 5	SC2A4-40L55	L 1,5 kW	R-S 3-F + SP, 10A	
CTVT/6-560	TS + DILM7-10	TK-21 + DILM7-10	RMT 8	SC2A4-60L55	L 2,2 kW	R-S 3-F + SP, 10A	
CTVT/6-630	TS + DILM9-10	TK-21 + DILM9-10	RMT 12	SC2A4-110L55	L 4,0 kW	R-S 3-F + SP, 10A	
CTVT/6-630H	TS + DILM15-10	TK-21 + DILM15-10	-	-	L 7,5 kW	R-S 3-F + SP, 16A	
CTVT/6-710	TS + DILM15-10	TK-21 + DILM15-10	-	-	L 7,5 kW	R-S 3-F + SP, 16A	
CTVT/6-710H	TS + DILM25-10	TK-21 + DILM25-10	-	-	L 11,0 kW	R-S 3-F + SP, 25A	
CTVT/8-450	TS + DILM7-10	TK-21 + DILM7-10	RMT 2,5	SC2A4-25L55	L 0,75 kW	R-S 3-F + SP, 10A	
CTVT/8-500	TS + DILM7-10	TK-21 + DILM7-10	RMT 2,5	SC2A4-25L55	L 0,75 kW	R-S 3-F + SP, 10A	
CTVT/8-560	TS + DILM7-10	TK-21 + DILM7-10	RMT 5	SC2A4-40L55	L 1,5 kW	R-S 3-F + SP, 10A	
CTVT/8-630	TS + DILM7-10	TK-21 + DILM7-10	RMT 5	SC2A4-60L55	L 2,2 kW	R-S 3-F + SP, 10A	
CTVT/8-710	TS + DILM9-10	TK-21 + DILM9-10	RMT 8	SC2A4-110L55	L 4,0 kW	R-S 3-F + SP, 10A	
CTVT/4/8-225N	TS + DILM7-10	TK-21 + DILM7-10	-	-	-	R-S 3-F + SP, 10A	
CTVT/4/8-250N	TS + DILM7-10	TK-21 + DILM7-10	-	-	-	R-S 3-F + SP, 10A	
CTVT/4/8-315N	TS + DILM7-10	TK-21 + DILM7-10	-	-	-	R-S 3-F + SP, 10A	0-Y-YY
CTVT/4/8-400N	TS + DILM7-10	TK-21 + DILM7-10	-	-	-	R-S 3-F + SP, 10A	0-Y-YY
CTVT/4/8-450	TS + DILM7-10	TK-21 + DILM7-10	-	-	-	R-S 3-F + SP, 10A	0-Y-YY
CTVT/6/12-450	TS + DILM7-10	TK-21 + DILM7-10	-	-	-	R-S 3-F + SP, 10A	0-Y-YY
CTVT/6/12-500	TS + DILM7-10	TK-21 + DILM7-10	-	-	-	R-S 3-F + SP, 10A	0-Y-YY
CTVT/6/12-560	TS + DILM7-10	TK-21 + DILM7-10	-	-	-	R-S 3-F + SP, 10A	0-Y-YY
CTVT/6/12-630	TS + DILM7-10	TK-21 + DILM7-10	-	-	-	R-S 3-F + SP, 10A	0-Y-YY
CTVT/6/12-710	TS + DILM7-10	TK-21 + DILM7-10	-	-	-	R-S 3-F + SP, 16A	0-Y-YY

AKCESORIA ELEKTRYCZNE

termostat TS	termostat TK-1	czujnik SQA	higrostat HIG-2	regulator REB	regulator TLR	regulator RMB/RMT	regulator RVS	falownik	przełącznik biegów	rozłącznik serwisowy

Numery artykułów

TS	40025345	RMB 10	40025090	R-S 3-F + SP, 40A	91040910-04	DILM12-10	91040666-47	RVS-A 3,0	40025241
TK-21	40025320	RVS 1,5	40025232	R-S 3-F + SP, 63A	91040911-03	DILM15-10	91040666-47	RVS-A 5,0	40025242
Czujnik temp. do TK-21	40025321	RVS 3	40025234	PRZEŁĄCZNIK BIEGÓW 0-Y-YY	91040913	DILM17-10	91040666-47	RVS-A 7,0	40025243
SQA	40025140	RVS 5	40025235	L 0,4 kW	40016302	DILM25-10	91040666-47	ERV-3	40025046
HIG-2	40025150	RVS 7	40025236	L 0,75 kW	40016312	DILM32-10	91040666-47	ERV-5	40025053
REB 1N	40025010	RVS 10	40025237	L 1,5 kW	40016322	DILM40-10	91040666-48	ERV-10	40025054
REB 1NE	40025020	RVS 14	40025238	L 2,2 kW	40016332	DILM50-10	91040666-48	RND-1	40025630
REB 2,5N	40025030	RMT 1,5	40025100	L 4,0 kW	40016352	IRF-900	40015154	SC2A4-15L55	40025270
REB 2,5NE	40025040	RMT 2,5	40025105	L 5,5 kW	40016362	TLR 3 TE	40025021	SC2A4-25L55	40025272
REB 5	40025051	RMT 5	40025115	L 7,5 kW	40016372	TLR 5 TE	40025022	SC2A4-40L55	40025274
REB 10	40025055	RMT 8	40025120	L 11,0 kW	40016383	TLR 10 TE	40025023	SC2A4-60L55	40025276
TLR 15DS	40025025	RMT 12	40025130	L 15,0 kW	40016392	SC2A1-15L25	40025251	SC2A4-80L55	40025278
TLR 25DS	40025045	R-S 1-F + SP, 16A	91040907-02	L 18,5 kW	40016412	SC2A1-25L25	40025253	SC2A4-110L55	40025280
RMB 1,5	40025060	R-S 3-F + SP, 10A	91040908-01	L 22,0kW	40016422	SC2A1-35L25	40025255		
RMB 3,5	40025070	R-S 3-F + SP, 16A	91040908-02	DILM7-10	91040666-47	SC2A1-75L25	40025259		
RMB 8	40025080	R-S 3-F + SP, 25A	91040910-01	DILM9-10	91040666-47	RVS-A 1,5	40025240		